



iBook G4

User's Guide

Includes setup, expansion, and
troubleshooting information for
your iBook G4 computer

 Apple Computer, Inc.
© 2005 Apple Computer, Inc. All rights reserved.

Under the copyright laws, this manual may not be copied, in whole or in part, without the written consent of Apple.

The Apple logo is a trademark of Apple Computer, Inc., registered in the U.S. and other countries. Use of the "keyboard" Apple logo (Option-Shift-K) for commercial purposes without the prior written consent of Apple may constitute trademark infringement and unfair competition in violation of federal and state laws.

Every effort has been made to ensure that the information in this manual is accurate. Apple is not responsible for printing or clerical errors.

Apple
1 Infinite Loop
Cupertino, CA 95014-2084
408-996-1010
www.apple.com

Apple, the Apple logo, AirPort, AppleTalk, Final Cut Pro, FireWire, iBook, iCal, iLife, iMovie, iPod, iTunes, Mac, Macintosh, and Mac OS are trademarks of Apple Computer, Inc., registered in the U.S. and other countries.

AirPort Express, Exposé, FileVault, Finder, the FireWire logo, iDVD, iPhoto, iSight, Safari, Spotlight, SuperDrive, and Tiger are trademarks of Apple Computer, Inc.

AppleCare and Apple Store are service marks of Apple Computer, Inc., registered in the U.S. and other countries.

.Mac is a service mark of Apple Computer, Inc.

ENERGY STAR® is a U.S. registered trademark.

The Bluetooth® word mark and logos are owned by the Bluetooth SIG, Inc. and any use of such marks by Apple Computer, Inc. is under license.

PowerPC is a trademark of International Business Machines Corporation, used under license therefrom.

Other company and product names mentioned herein are trademarks of their respective companies. Mention of third-party products is for informational purposes only and constitutes neither an endorsement nor a recommendation. Apple assumes no responsibility with regard to the performance or use of these products.

The product described in this manual incorporates copyright protection technology that is protected by method claims of certain U.S. patents and other intellectual property rights owned by Macrovision Corporation and other rights owners. Use of this copyright protection technology must be authorized by Macrovision Corporation and is intended for home and other limited viewing uses only unless otherwise authorized by Macrovision Corporation. Reverse engineering or disassembly is prohibited.

Apparatus Claims of U.S. Patent Nos. 4,631,603, 4,577,216, 4,819,098 and 4,907,093 licensed for limited viewing uses only.

Simultaneously published in the United States and Canada.

Contents

Chapter 1	5 Getting Started
	6 Setting Up Your iBook G4
	12 Basic Features of Your iBook G4
	14 Additional Features of Your iBook G4
	16 Putting Your iBook G4 to Sleep or Shutting It Down
	17 Calibrating Your Battery
	18 Getting More Information
Chapter 2	19 Getting to Know Your iBook G4
	20 Adjusting Your Display
	21 Using Your Power Adapter
	22 Using the Trackpad
	23 Using the Keyboard
	23 Using a Mouse
	24 Learning About Mac OS X
	24 Customizing Your Desktop and Setting Your Preferences
	25 Getting Answers Using Mac Help
	26 Using Applications
	26 When an Application Does Not Respond
	27 Connecting to a Network
	27 Using the Internet
	27 Keeping Your Software Up to Date
	28 Connecting to a Printer
	29 Playing a CD and Connecting Headphones
	30 Connecting a Camera or Other FireWire or USB Device
	30 Transferring Files to Another Computer
Chapter 3	31 Using Your iBook G4
	32 Using Universal Serial Bus (USB) Devices
	34 Connecting With FireWire
	36 Understanding AirPort Extreme Wireless Networking
	37 Using Bluetooth Wireless Technology
	40 Connecting With Ethernet (10/100Base-T)

	41	Using Your Modem
	41	Using External Video Support (VGA, Composite, and S-Video)
	43	Connecting Speakers and Other Audio Devices
	43	Using Your Optical Drive
	47	Understanding Sudden Motion Sensor
	47	Using Your Battery
	51	Securing Your iBook G4
Chapter 4	53	Adding Memory to Your iBook G4
	54	Installing Additional Memory
	59	Making Sure Your iBook G4 Recognizes the New Memory
Chapter 5	61	Troubleshooting
	61	Problems That Prevent You From Using Your Computer
	63	Other Problems
	64	Using Apple Hardware Test
	65	Reinstalling the Software That Came With Your Computer
	66	Locating Your Product Serial Number
Appendix A	67	Specifications
Appendix B	69	Care, Use, and Safety Information
	69	Cleaning Your iBook G4
	69	Carrying Your iBook G4
	70	Storing Your iBook G4
	70	Safety Instructions for Setting Up and Using Your iBook G4
	71	Understanding General Safety Instructions
	72	Handling the Battery
	72	Avoiding Hearing Damage
	73	Understanding Ergonomics
	74	Learning About Apple and the Environment
Appendix C	75	Connecting to the Internet
	77	Gathering the Information You Need
	78	Entering Your Information
	78	Connecting With a Dial-Up Modem
	80	Connecting With DSL, Cable Modem, or LAN
	86	Configuring Your AirPort Wireless Connection
	89	Troubleshooting Your Connection
Appendix D	91	Top Ten Questions
	95	Communications Regulation Information
Index	101	

Your iBook G4 is a full-featured notebook computer.

Your iBook G4 includes the following components:

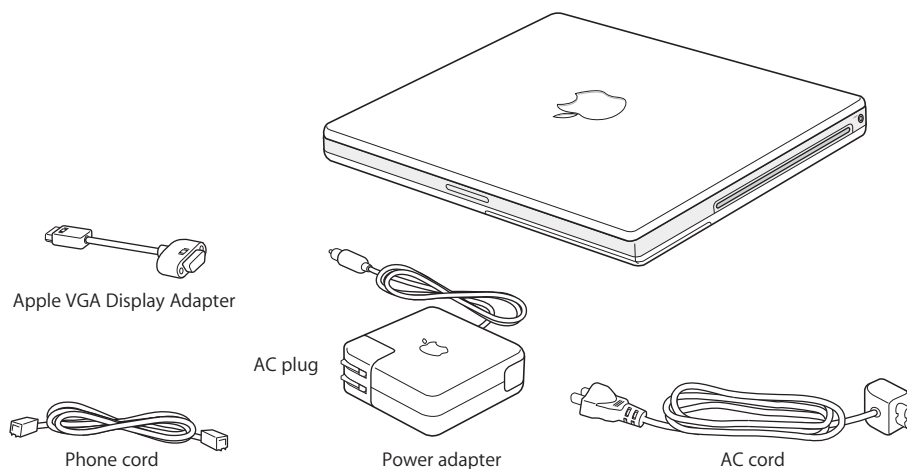

Important: Read all the installation instructions and safety information (see Appendix B, “Care, Use, and Safety Information,” on page 69) carefully before you plug your computer in to a wall socket.

Setting Up Your iBook G4

Your iBook G4 is designed so that you can set it up quickly and start using it right away. The following pages take you through the setup process, including these tasks:

- Plugging in the power adapter
- Connecting the cables
- Turning on your iBook G4

Step 1: Plug In the Power Adapter

If there is protective film around the power adapter, remove it before setting up your iBook.

- Insert the AC plug of your power adapter in to an outlet and the power adapter plug in to the iBook power adapter port.

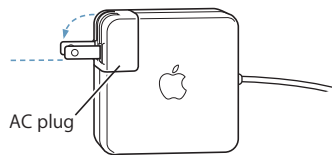

Important: Make sure the electrical prongs on your AC plug are in their completely extended position before you plug the adapter in to the outlet.

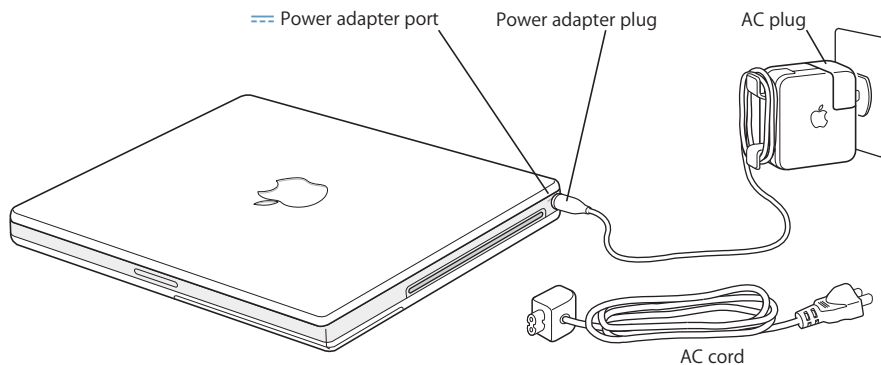

To extend the reach of your power adapter, you can attach the AC cord. First remove the AC plug from the adapter, and then attach the included AC cord to the adapter. Insert the other end in to a wall outlet. For an illustration, see page 21.

Step 2: Connect Your Cables

Next, for an Internet connection, connect your iBook to a telephone line, DSL modem, cable modem, or Ethernet network. If you're connecting to a wireless AirPort Extreme network, you don't need cables.

To connect to a phone line:

- Connect the phone cord from a wall jack to the internal modem port for a dial-up connection.

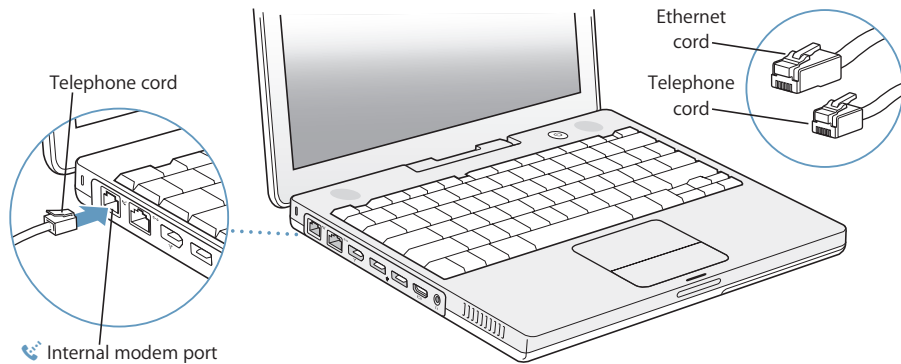

Make sure you connect the internal modem to an analog phone line—the kind typically used in homes. The modem will not work with a digital phone line.

Warning: Do not connect a digital phone line to the modem; the wrong type of line could damage the modem. Contact your telephone service provider if you are unsure whether you have a digital phone line.

For more information about your modem, see “Using Your Modem” on page 41. For information about other types of connections, see Appendix C, “Connecting to the Internet,” on page 75.

To connect to a DSL or cable modem or an Ethernet network:

- Connect the cable to your DSL or cable modem as shown in the modem instructions, or connect the Ethernet cord to the Ethernet hub or outlet. Then connect the other end of the cord to the computer's Ethernet port.

Make sure you plug the Ethernet cord, and not the phone cord, in to the Ethernet port.

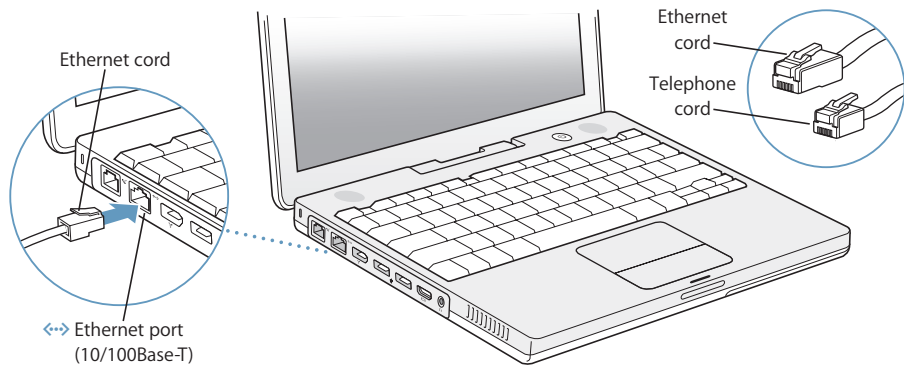

Step 3: Turn On Your iBook G4

You've done everything you need to set up your iBook. The first time you turn on your computer, Setup Assistant starts. Setup Assistant helps you enter your Internet and email information and set up a user on your computer.

If you already have a Mac, Setup Assistant can help you automatically transfer files, applications, and other information from your previous Mac to your new iBook.

To transfer information, make sure:

- Your other Mac has built-in FireWire and supports FireWire Target Disk Mode.
- Your other Mac has Mac OS X v10.1 or later installed.
- You have a standard 6-pin to 6-pin FireWire cable.

Setup Assistant takes you through the process of transferring your information—just follow the onscreen instructions. Transferring information to your iBook does not affect the information on your other Mac. Using Setup Assistant, you can transfer:

- User accounts, including preferences and email
- Network settings, so your new iBook is automatically set up to work with the same network settings as your other Mac
- Files and folders on the hard disk and partitions. This gives you easy access to the files and folders you used on your old Mac.
- The Applications folder, so that most of the applications you used on your other Mac are now on your new iBook (you might have to reinstall some of the applications you transfer)

Important: Use caution when you transfer applications so that you don't overwrite later versions of the applications already installed on your iBook.

If you don't intend to keep or use your other Mac, you may want to deauthorize your old computer to play music or spoken word files that you've purchased from the iTunes Music Store. Deauthorizing a computer prevents any songs or audiobooks you've purchased from being played by someone else.

If you don't use Setup Assistant to transfer information when you first start up your iBook, you can do it later using Migration Assistant. Go to the Applications folder, open Utilities, and double-click Migration Assistant.

Note: If you used Setup Assistant to transfer information from an older Macintosh and you want to use Migration Assistant to transfer information from it again, make sure FileVault is turned off on the older Macintosh. To turn off FileVault, open the Security pane of System Preferences and click Turn Off FileVault. Follow the onscreen instructions.

Setup Assistant can also take you through the process of setting up your computer to connect to the Internet. For home users, Internet access requires an account with an Internet service provider (ISP). Fees may apply. If you already have an Internet account, see Appendix C, "Connecting to the Internet," on page 75 for information you'll need to enter.

- 1 To turn on your iBook G4, press the power button (⏻).

You hear a tone when you turn on the computer. It takes the computer a few moments to start up. After it starts up, Setup Assistant opens automatically.

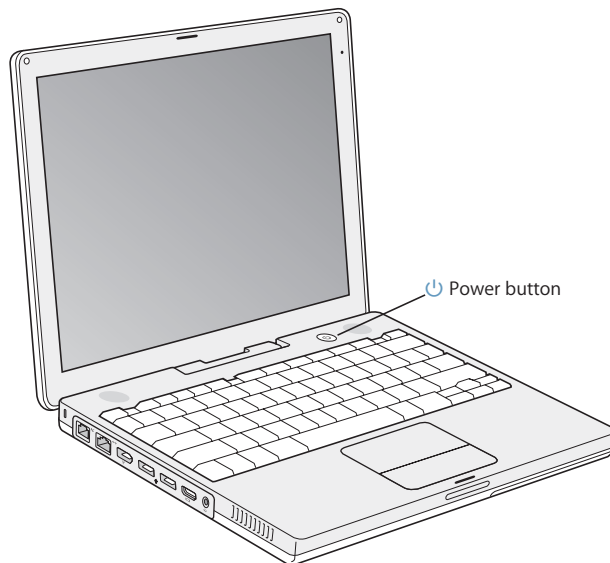

Note: To start up your computer, press the power button (⏻) only once briefly (up to 1 second). Do not continue to hold down or press the power button after the startup tone or you might cause the computer to shut down again.

2 Use your iBook trackpad to select and move items on the screen, just like you use a mouse with a desktop computer.

- To move the arrow pointer on the screen, slide your finger across the trackpad.

Important: Use one finger on the trackpad to move the pointer. The trackpad is designed to allow scrolling when you use two adjoining fingers and the scrolling feature is turned on. See “Using the Trackpad” on page 22 for more information.

- To select, click, or double-click an item on the screen, use the trackpad button.

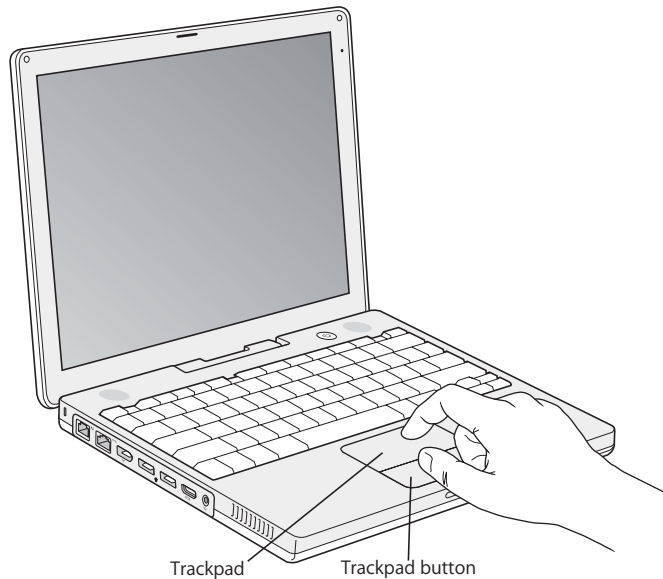

For tips on using the trackpad, see “Tips for Using the Trackpad” on page 22.

Congratulations, you're up and running!

Problems Turning On the Computer?

Nothing happens when you press the power button (⏻).

- The battery might be drained. Make sure that you plugged the power adapter firmly in to both the computer and a power source. The plug should light when you plug it in to the computer.
- If the computer still doesn't start up, see "Problems That Prevent You From Using Your Computer" on page 61.

You see a picture of a disk or a folder with a blinking question mark.

- This icon usually means that the computer can't find system software on the hard disk or any disks attached to the computer. Try restarting. Hold down the power button (⏻) for 4 to 5 seconds until the computer turns off. Then press the power button again. If the problem persists, you might need to reinstall system software. See "Reinstalling the Software That Came With Your Computer" on page 65.

Basic Features of Your iBook G4

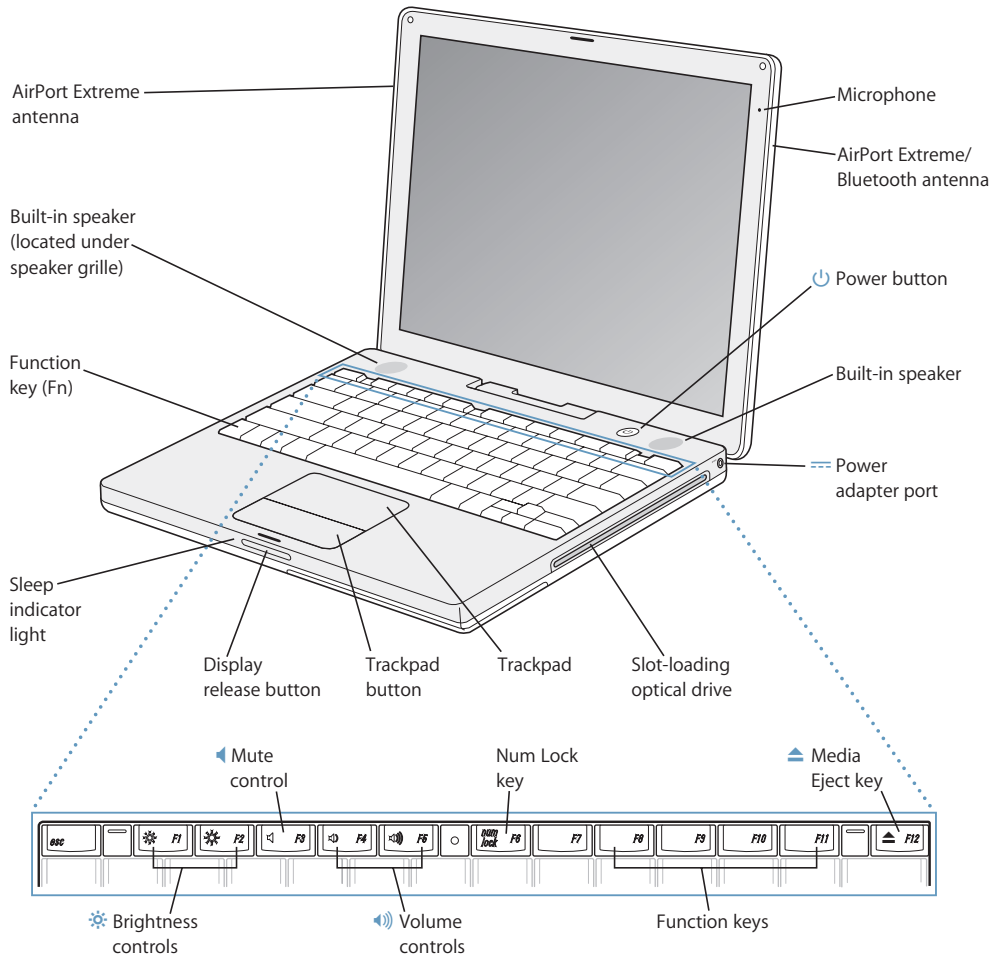

**Brightness controls**

Increase or decrease the brightness of your iBook display.

**Volume controls**

Increase or decrease the volume of the sound coming from the built-in speakers and headphone port.

Num Lock key

Activate the numeric keypad embedded in the iBook keyboard. When the numeric keypad is activated, a green light glows on the key.

**Media Eject key**

Press and hold this key to eject a disc. You can also eject a disc by dragging its desktop icon to the Trash.

Microphone

Record sounds directly on your iBook hard disk with this built-in microphone (located to the upper right of the display).

Built-in stereo speakers (2)

Listen to music, movies, games, and multimedia files.

Function (Fn) key

Press and hold this key to activate the function keys (F1 to F12).

Sleep indicator light

A white light pulsates when the iBook is in sleep.

Display release button

Push this button to release your display and open your iBook.

Trackpad

Move the pointer on the iBook display with one finger on the trackpad; scroll with two fingers on the trackpad. (Turn scrolling on or off in the Keyboard & Mouse pane of System Preferences.) See “Using the Trackpad” on page 22 for more information about moving the pointer and scrolling with the trackpad.

Slot-loading optical drive

Your optical drive can read CD-ROM discs, photo CDs, standard audio discs, DVD-ROM and DVD-R discs, DVD movies, and other kinds of media. It can also write music, documents, and other digital files to CD-R and CD-RW discs. If you have a SuperDrive, you can also write to DVD-R, DVD+R, DVD-RW, and DVD+RW discs. See “Using Your Optical Drive” on page 43 for details.

**Power button**

Turn your iBook on and off or put it to sleep.

**Power adapter port**

Plug in the included power adapter to recharge your iBook battery.





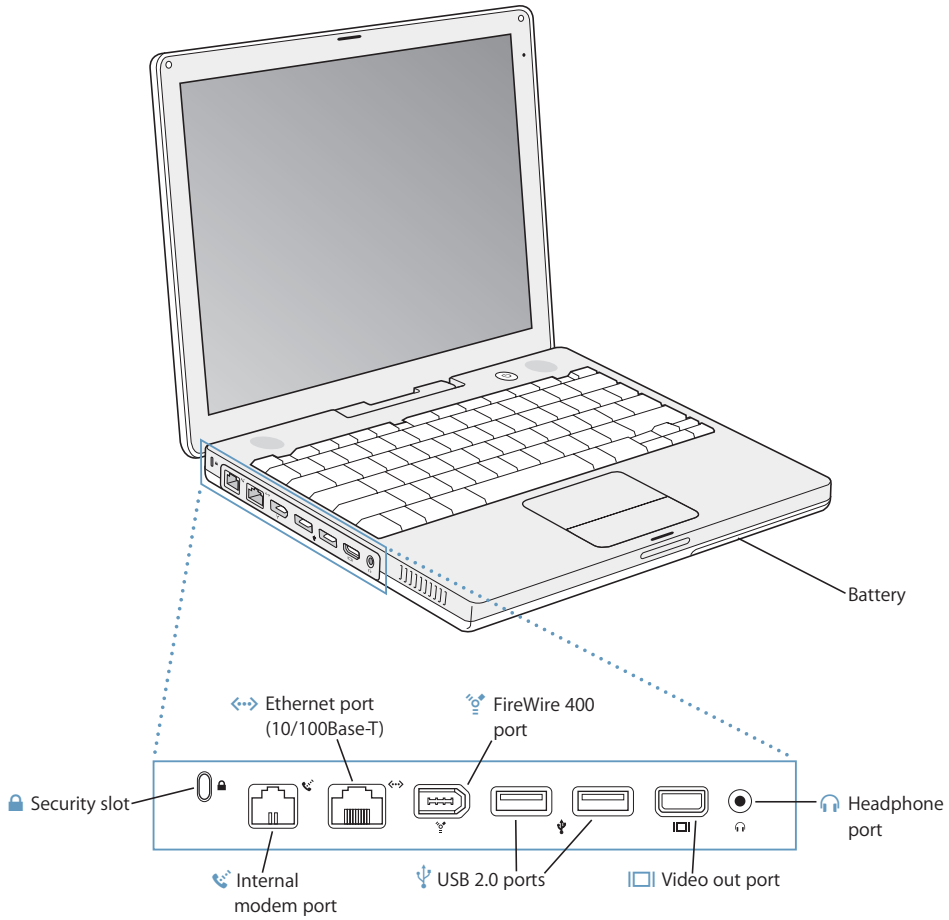

AirPort Extreme/Bluetooth antenna

With an optional AirPort Extreme Base Station, AirPort Express, or other wireless access point, connect to the Internet wirelessly. You can also wirelessly connect to devices equipped with Bluetooth® wireless technology, such as mice, keyboards, personal digital assistants, and cell phones.

For additional information about AirPort Extreme or your optical drive, see Chapter 3, “Using Your iBook G4,” on page 31.

Additional Features of Your iBook G4



-
-  **Internal modem port**
Connect a standard phone line directly to the internal modem.
 -  **Ethernet port (10/100Base-T)**
Connect to a high-speed 10/100Base-T Ethernet network or connect to another computer and transfer files. The Ethernet port auto-sensing feature detects other Ethernet devices. You don't need an Ethernet crossover cable to connect to other Ethernet devices.
 -  **FireWire 400 port**
Connect high-speed external devices, such as digital videocameras and external storage devices.
 -  **Two USB 2.0 (Universal Serial Bus) ports**
Connect additional equipment to your iBook, such as printers, external storage devices, digital cameras, modems, keyboards, and joysticks.
 -  **Video out (external monitor) port**
Connect to an external monitor or projection device that uses a VGA connector with the included Apple VGA Display Adapter. You can also use an Apple Video Adapter (sold separately) to connect to a TV, VCR, or another video device.
 -  **Headphone (audio line out) port**
Connect external speakers, headphones, or other sound output devices.
 -  **Security slot**
Protect your iBook from theft by connecting a security cable (sold separately).
-

For additional information about these features, see Chapter 3, "Using Your iBook G4," on page 31.

Putting Your iBook G4 to Sleep or Shutting It Down

When you finish working with your iBook, you can put it to sleep or shut it down.

Putting Your iBook G4 to Sleep

If you will be away from your iBook for only a short time, put the computer to sleep. When the computer is in sleep, you can quickly wake it and bypass the startup process.

To put the computer to sleep, do one of the following:

- Close the display.
- Choose Apple () > Sleep from the menu bar.
- Press the power button (⏻) and click Sleep in the dialog that appears.



Warning: Wait a few seconds until the white sleep indicator light next to the display latch starts pulsating (indicating that the computer is in sleep and the hard disk has stopped spinning) before you move your iBook. Moving your computer while the hard disk is spinning can damage the hard disk, causing loss of data or the inability to start up from the hard disk.

To wake the computer:

- *If the display is closed*, open it. Your iBook automatically wakes from sleep when you open the display.
- *If the display is already open*, press the power button (⏻) or any key on the keyboard.

Shutting Down Your iBook G4

If you aren't going to use your iBook for a day or two, shut it down.

To shut down your computer, do one of the following:

- Choose Apple () > Shut Down from the menu bar.
- Press the power button (⏻) and click Shut Down in the dialog that appears.



If you plan to store your iBook for an extended period of time, see “Storing Your iBook G4” on page 70 for information about how to prevent your battery from draining completely.

Calibrating Your Battery

To get the longest running time from your battery, calibrate it sometime during the first week you have your iBook.

To calibrate your battery, follow these steps:

- 1 Plug in the power adapter and fully charge your iBook battery until the light on the power adapter plug changes to green and the onscreen meter in the menu bar indicates that the battery is fully charged.

- 2 Disconnect the power adapter and start using your iBook.

When your battery gets low, you will see the first low-battery warning dialog on the screen. Continue to use your iBook until it automatically goes to sleep; at that point the battery has been sufficiently drained for calibration.

- 3 Connect the power adapter and leave it connected until the battery is fully charged again.

Important: You need to fully discharge and then charge your battery only once to calibrate it. After that, you can connect and disconnect the power adapter when the battery is at any charge level.

If you purchased additional batteries, repeat the calibration procedure with the additional batteries as well. For more information about your power adapter and battery, see “Using Your Power Adapter” on page 21 and “Using Your Battery” on page 47.

Getting More Information

- Learn the important basics about your iBook. Check out Chapter 2, “Getting to Know Your iBook G4,” on page 19.
- Have fun trying out your computer’s applications and Internet features. Browse the *Welcome to Tiger* booklet that came with your computer.
- If you’re unfamiliar with Mac OS X, open Mac Help and browse the information there. For more information, see “Getting Answers Using Mac Help” on page 25.
- If you’re having a problem that prevents you from using your computer, see Chapter 5, “Troubleshooting,” on page 61.
- Check out the top ten most commonly asked questions. See Appendix D, “Top Ten Questions,” on page 91.
- For support information, user discussion boards, and the latest Apple software downloads, go to www.apple.com/support.
- If you can’t find the answer to your question in these places, see the AppleCare materials that came with your computer for information about contacting Apple.

This chapter introduces important basics about your iBook G4.

Because your iBook is so thin and light, you can take it with you to the office, library, class, or wherever you work or play.

Whenever you stop using your iBook, wait a few moments to let the hard disk and any optical disc (such as a CD or DVD) in your drive stop spinning before you transport the computer. Avoid jostling or bumping your iBook while discs are spinning.

Note: Your iBook uses Sudden Motion Sensor technology to help protect the hard disk if the computer is dropped or experiences extreme vibration. See “Understanding Sudden Motion Sensor” on page 47 for more information.

When you use your iBook or charge its battery, it is normal for the bottom of the case to get warm. For prolonged use, place your iBook on a flat, stable surface. The bottom of the case is raised slightly to allow airflow that keeps the unit within normal operating temperatures.

As you get to know your new computer, you might hear small noises during startup and when using your hard disk and optical drive. For example, your hard disk and optical drive might whirl and click as they access information or load and eject discs. After the iBook runs for some time, a small fan might turn on to cool it, producing a faint sound. Small noises are part of the computer’s normal functioning.

For more safety instructions about handling and using your iBook in different locations, be sure to see Appendix B, “Care, Use, and Safety Information,” on page 69.

Adjusting Your Display

After you begin working with your new iBook, you might need to adjust your display so that the screen is easier to see. Use the keys labeled with the brightness icon (☼) to adjust screen brightness.

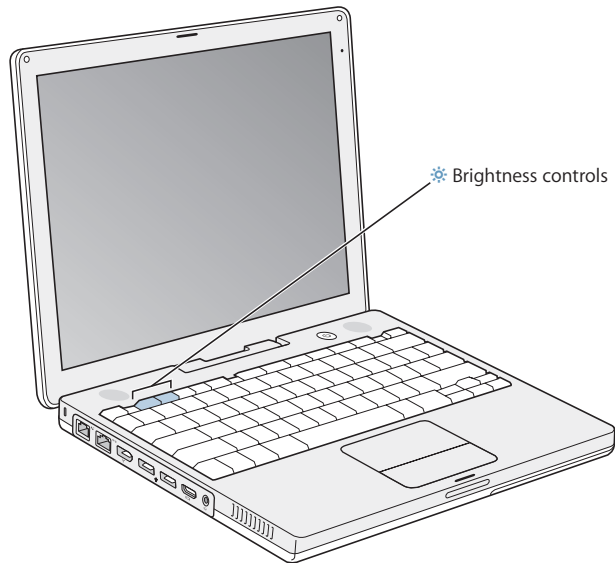

You can increase or decrease the size of images on your display by switching screen resolutions.

You can choose a resolution in the Displays pane of System Preferences. Some resolutions enlarge items on the screen, making them easier to see. However, items might not be as sharp at some resolutions as they are at the display's default resolution.

To adjust the resolution on your display:

- Choose Apple () > System Preferences from the menu bar. Open the Displays pane of System Preferences.

To control your display settings using the Displays icon in the menu bar, click “Show displays in menu bar.”

Using Your Power Adapter

Plugging in the power adapter provides AC power to the iBook and recharges the computer's battery.

Important: For optimal performance, use only the power adapter that came with your computer.

When you first connect your power adapter to your computer, an indicator light turns on. An amber light indicates that the battery is being charged. A green light indicates that the battery is fully charged. You can monitor the battery level using the Battery icon in the menu bar or by checking the battery level indicator lights on the bottom of the battery (see page 47).

To extend the reach of your power adapter, remove the AC plug from the adapter. Attach the included AC cord to the adapter and insert the other end in to a wall outlet.

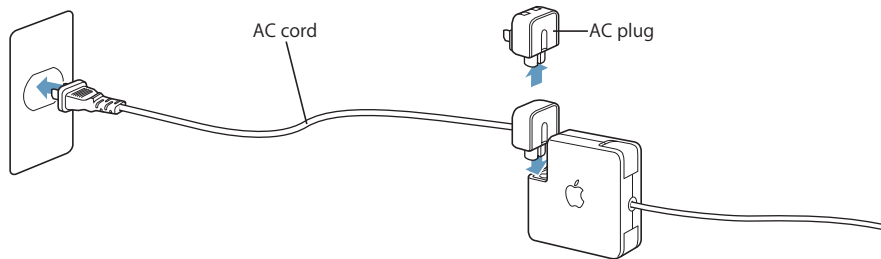

Warning: Make sure the power adapter is fully assembled before plugging it in to an electrical outlet. If you're using the AC plug with your power adapter, make sure the prongs are in their completely extended position before plugging in the adapter.

Use only the AC cord that came with your power adapter. Make sure to push the power plug snugly in to the power adapter port on the computer to ensure it is engaged and power is flowing to the computer.

When disconnecting the power adapter from an outlet or from the computer, pull the plug, not the cord.

For safety instructions about using your power adapter, see "Plugging In the Power Adapter" on page 70.

Using the Trackpad

How quickly the pointer moves onscreen is based on how quickly you move your finger across the trackpad. To move the pointer a short distance, move your finger slowly across the trackpad. The faster you move your finger, the farther the pointer moves onscreen.

Tips for Using the Trackpad

For best results when using the trackpad, keep in mind these tips:

- Use only one finger, except when the scrolling feature is turned on and you want to scroll.
- Do not use a pen or any other object.
- Keep your finger and the trackpad dry. If the trackpad becomes moist from humidity or condensation, gently wipe it with a clean cloth before you use it.
- Never use any kind of cleaning solution on the trackpad.

For more information about using the trackpad, choose Help > Mac Help from the menu bar at the top of the screen.

Instead of using the trackpad button, you can use your finger to click and double-click directly on the trackpad. You can turn on this feature and other trackpad options in the Keyboard & Mouse pane of System Preferences.

You can also scroll vertically and horizontally in a window that has scroll bars by moving two adjoining fingers on the trackpad. You can select this option in the Keyboard & Mouse pane of System Preferences.

Note: If you find that the pointer moves as you type because you accidentally brush the trackpad, you can avoid this problem by selecting the “Ignore accidental trackpad input” option in the Keyboard & Mouse pane of System Preferences.

Using the Keyboard

Your iBook keyboard has a numeric keypad incorporated in the standard keyboard keys. Keys used for the numeric keypad have a smaller secondary label.

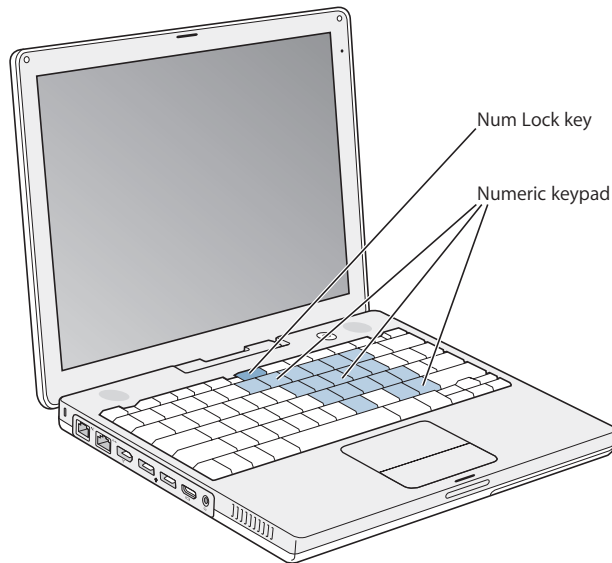

To use the numeric keypad, press the Num Lock key. An indicator light glows green, indicating that the keypad is active. When you finish using the keypad, press the Num Lock key again to turn it off.

Important: If your keyboard doesn't seem to be working correctly, check the Num Lock key. When the numeric keypad is active, other keys and keyboard equivalents for menu commands (such as \mathbb{A} -Q to quit) are deactivated.

If you like to use keyboard shortcuts to work efficiently, open Mac Help and search for "navigation shortcuts." You'll find an extensive list of keyboard shortcuts for many common procedures and applications.

Using a Mouse

If you have an Apple mouse with a USB connector, you can insert the USB connector in to the USB 2.0 port and use your mouse right away. If you have an Apple wireless mouse, see "Using Bluetooth Wireless Technology" on page 37 for information about connecting it. You can purchase a wireless or USB mouse from an Apple Authorized Reseller or, if you prefer, from the online Apple Store at www.apple.com/store.

Learning About Mac OS X

Your computer comes with Tiger, the latest version of Mac OS X, which includes Spotlight, an improved search engine that automatically indexes all of your files; Dashboard, an interface for putting handy “widgets” or mini-applications at your fingertips; Exposé, which tiles and neatly displays all your open applications; and much more.

When you’re ready to learn more about Mac OS X and the award-winning iLife applications that came with your computer, see the *Welcome to Tiger* booklet that came with your iBook. Also open Mac Help and browse the information there. You’ll find plenty of information for new users, experienced users, and users switching to the Mac. If you experience any problems while using Mac OS X, see Chapter 5, “Troubleshooting,” or choose Help > Mac Help from the menu bar at the top of the screen.

For information about the software applications compatible with Mac OS X, or to read more about Mac OS X, check the Apple website at www.apple.com/macosx.

Note: If you want to use Classic applications with your computer, you have to install a version of Mac OS 9 that supports the Classic environment (see “Installing Mac OS 9” on page 66). Mac OS 9 can’t be installed as the primary operating system on your iBook, and you can’t start up your computer in Mac OS 9.

Customizing Your Desktop and Setting Your Preferences

You can quickly make your desktop look the way you want using System Preferences. Choose Apple () > System Preferences from the menu bar.



Feel free to make changes and experiment with the following:

- *Appearance*: Select this preference pane to change the colors of buttons, menus, windows, and highlight colors, among other options.
- *Dashboard & Exposé*: Select this preference pane to set active screen corners and shortcuts for Dashboard, your desktop, your application windows, and all windows.
- *Desktop & Screen Saver*: Select this preference pane to change the background color or pattern of your desktop, or change it to a photo or other custom image. You can also choose an eye-catching screen effect that will appear on your screen when the computer is left idle.
- *Dock*: Select this preference pane to change the look, location, and behavior of your Dock (the bar of icons at the bottom of the screen).

As you get to know your computer, explore the other system preferences. System Preferences is your command center for most settings on your iBook. For more information, open Mac Help and search for “System Preferences” or for the specific preference pane you want to change.

Note: Because Apple frequently releases new versions and updates to its system software, applications, and Internet sites, images shown in this book might be slightly different from what you see on your screen.

Getting Answers Using Mac Help

Most of the information about using your Macintosh is available right on your computer in Mac Help.

To get Mac Help:

- 1 Click the Finder icon in the Dock (the bar of icons at the bottom of the screen).



- 2 Choose Help > Mac Help (click the Help menu in the menu bar and choose Mac Help).

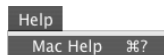

- 3 Click in the Search field, type a question, and press Return on your keyboard.



Using Applications

Your iBook comes with software applications, including the iLife suite of applications, for doing things like sending email, surfing the Internet, chatting online, organizing music and digital photos, making movies, and much more. For more information about these applications, see the *Welcome to Tiger* booklet that came with your computer.

When an Application Does Not Respond

On rare occasions, an application can “freeze” on the screen. Mac OS X provides a way to quit a frozen application without restarting your computer. Quitting a frozen application might allow you to save your work in other open applications.

To force an application to quit:

- 1 Press Command (⌘)-Option-Esc or choose Apple () > Force Quit from the menu bar. The Force Quit Applications dialog appears with the application selected.



- 2 Click Force Quit.

The application quits, leaving all other applications open.

If you need to, you can force the Classic environment to quit, which closes all Classic applications. You can also restart the Finder from this dialog.

If you're experiencing other problems with an application, see Chapter 5, "Troubleshooting," on page 61.

Connecting to a Network

If you want to connect your iBook to an Ethernet network or a wireless network, see "Connecting With Ethernet (10/100Base-T)" on page 40 and "Understanding AirPort Extreme Wireless Networking" on page 36 for more information about setting up an Ethernet or AirPort connection. Also open Mac Help and search for "Ethernet" or "AirPort" for further help.

Using the Internet

During the initial setup, you learned how to connect to the Internet. If you need to change to a different type of connection, such as DSL, cable modem, Ethernet local area network (LAN), or AirPort Extreme network, you can find more information in Appendix C, "Connecting to the Internet," on page 75.

Keeping Your Software Up to Date

You can connect to the Internet and automatically download and install the latest free software versions, drivers, and other enhancements from Apple.

When you are connected to the Internet, Software Update checks Apple's Internet servers to see if any updates are available for your computer. You can set your Mac to check the Apple servers periodically and download and install updated software.

To check for updated software:

- 1 Open System Preferences.
- 2 Click the Software Update icon and follow the directions on the screen.



- For more information, search for “Software Update” in Mac Help.
- For the latest information about Mac OS X, go to the Mac OS X website at www.apple.com/macosx.

Connecting to a Printer

Follow the instructions that came with your printer to install required software and connect the printer. The drivers for most printers are built in to Mac OS X.

You can connect many printers with a USB cable; others require a network connection, such as Ethernet. If you have an AirPort Express or AirPort Extreme Base Station, you can connect a USB printer to the base station (instead of connecting it to your computer) and print wirelessly. For more information about your USB ports, see “Using Universal Serial Bus (USB) Devices” on page 32. For more information about a wireless or network connection, see “Understanding AirPort Extreme Wireless Networking” on page 36 and “Connecting With Ethernet (10/100Base-T)” on page 40.

After you connect a USB or FireWire printer, your computer usually detects it automatically and adds it to the list of available printers. You might need to know the network name or address of printers connected to a network before you can print to them. Use the Print & Fax pane of System Preferences to select your printer.

To set up a printer:

- 1 Open System Preferences and click the Print & Fax icon.
- 2 Click Printing and then click the Add button (+) to add a printer.
- 3 Select the printer you want to use, and then click Add.

- 4 Use the Add button (+) and the Remove button (–) to choose the printers that appear in the printer list.

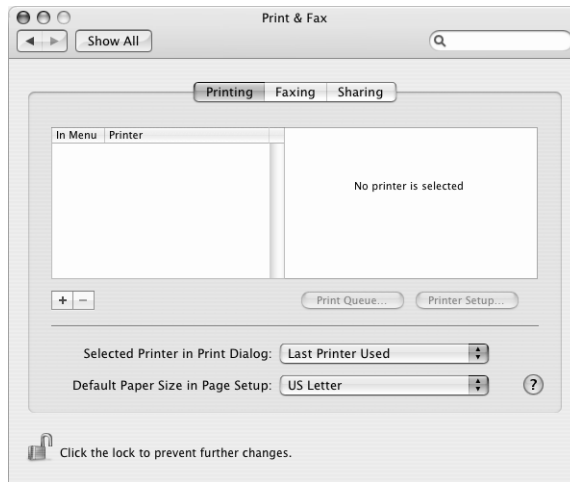

Monitoring Printing

After you send a document to a printer, you can monitor printing, including halting your print job or putting it temporarily on hold.

To monitor printing:

- Click the printer icon in the Dock to open the printer window.

You can now see the print jobs in the print queue and work with them. For more information, open Mac Help and search for “printing.”

Playing a CD and Connecting Headphones

You can use iTunes, an easy-to-use music player, to listen to your iTunes music and CDs while you work. Insert a music CD in your optical drive and iTunes will appear automatically on the screen. You can listen to your music on the iBook internal speakers or connect headphones with a minijack to the headphone port of your iBook for private listening right away.

To learn more about iTunes:

- Open iTunes and choose Help > “iTunes and Music Store Help.”

To learn more about your optical drive, see “Using Your Optical Drive” on page 43.

Warning: Listening to music at high volume over extended periods of time can damage your hearing.

Connecting a Camera or Other FireWire or USB Device

If you have an iPod, iSight camera, digital camera, videocamera, scanner, or other device that has a FireWire or USB connector, you can connect it to your iBook. Follow the installation instructions that came with your device. For more information about FireWire, see “Connecting With FireWire” on page 34. For more information about USB, see “Using Universal Serial Bus (USB) Devices” on page 32.

Transferring Files to Another Computer

If you want to transfer files or documents to or from your iBook, you can use one of several common ways to do it:

- You can easily transfer files using Migration Assistant and a FireWire cable (sold separately). You can also connect to another Mac using a FireWire cable and start up your iBook in FireWire Target Disk Mode. Your iBook appears as a hard disk on the other computer and you can drag files to it. For information about using FireWire to transfer files, see “Connecting Your iBook G4 to Another Computer Using FireWire” on page 35.
- If you have an external hard disk drive or Zip drive or other data storage device that connects through a USB or FireWire cable, you can use it to transfer files.
- If you have an email connection, you can email your files to another computer.
- If you sign up for a .Mac account from Apple (fees apply), you can use it to transfer files. With a .Mac account, you get Internet access and an iDisk. Your iDisk provides Internet space for backing up and storing files, so other computers can access the files you transfer there.
- If you connect your computer to a network using Ethernet, you can transfer files to another computer on the network. You can access a server or another computer by clicking Network in the Finder sidebar, or by choosing Go > Connect to Server from the menu bar.
- You can create a small Ethernet network by connecting an Ethernet cable from your iBook to another computer’s Ethernet port. After you’re connected, you can transfer files directly from one computer to the other. For more information, open Mac Help and search for “connecting two computers.”
- Your iBook includes AirPort Extreme, so you can connect to an AirPort Extreme wireless network to transfer files. For more information, see “Understanding AirPort Extreme Wireless Networking” on page 36.
- If you have access to devices that communicate using Bluetooth wireless technology, you can transfer files to other Bluetooth equipped devices. For more information, see “Using Bluetooth Wireless Technology” on page 37.

For general information about transferring files and documents, open Mac Help and search for “transferring” or for the type of connection you need.

Your iBook G4 has many built-in features and connection capabilities.

These include the following:

- Universal Serial Bus (USB) 2.0 ports for connecting additional equipment such as printers, scanners, and other devices. See “Using Universal Serial Bus (USB) Devices” on page 32.
- FireWire (400) port for connecting high-speed equipment such as digital videocameras and external hard drives. See “Connecting With FireWire” on page 34.
- Bluetooth wireless connectivity and AirPort Extreme wireless networking capability. See “Understanding AirPort Extreme Wireless Networking” on page 36 and “Using Bluetooth Wireless Technology” on page 37.
- Ethernet networking capability and a 56K modem for networking and communications. See “Connecting With Ethernet (10/100Base-T)” on page 40.
- Video out port with the included Apple VGA Display Adapter for using your iBook with an external monitor or display. Use an Apple Video Adapter (sold separately) to connect a TV, VCR, or other video device. See “Using External Video Support (VGA, Composite, and S-Video)” on page 41.
- Slot-loading optical drive for playing CDs and DVDs and burning CDs. If you have a SuperDrive, you can burn DVDs as well. See “Using Your Optical Drive” on page 43.
- Sudden Motion Sensor technology that helps protect the internal hard disk if the iBook is dropped or experiences severe vibration. See “Understanding Sudden Motion Sensor” on page 47.
- Headphone port for connecting headphones, speakers, and other audio equipment. See “Connecting Speakers and Other Audio Devices” on page 43.
- iBook battery that provides convenient, at-a-glance battery status. See “Using Your Battery” on page 47.
- Security slot so that you can make sure your iBook stays where it should. See “Securing Your iBook G4” on page 51.

Using Universal Serial Bus (USB) Devices

Your iBook G4 comes with two USB 2.0 ports (⌘), also referred to as Hi-Speed USB, which you can use to connect many types of external devices, including printers, scanners, digital cameras, game pads, joysticks, keyboards, and floppy disk drives. Your USB 2.0 ports are compatible with earlier USB devices. In most cases, you can connect and disconnect a USB device while the computer is running. After you connect the device, it is ready to use. You don't need to restart or reconfigure your computer.

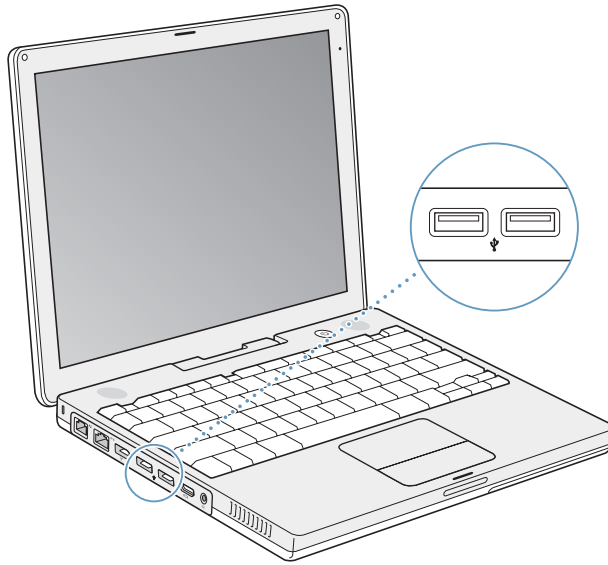

To use a USB device with your computer, connect the device to the computer. Apple has already included software to work with many USB devices. Your computer automatically detects newly connected devices.

Note: If your iBook cannot find the correct software when you connect a USB device, you can either install the software that came with the device or follow the onscreen prompts to use the Internet to locate, download, and install the correct software.

Understanding USB Devices and Battery Power

You can use USB devices, such as joysticks and keyboards, that get power from the iBook USB connection instead of from a separate power adapter. However, these types of USB devices can cause your iBook battery to become depleted faster. If you are using the device for an extended period, it is a good idea to connect the iBook power adapter.

Using Multiple USB Devices at the Same Time

You can purchase a USB hub to connect multiple USB devices to your computer. The USB hub connects to an open USB port on your computer and provides additional USB ports (usually four or seven). Hi-Speed hubs can support USB 2.0 Hi-Speed devices as well as USB 1.1 compatible devices. USB 1.1 hubs don't allow Hi-Speed USB devices to operate at their maximum data speed. Most USB hubs have a power adapter and should be plugged in to an outlet.

Note: If you are using a chain of USB devices and hubs, some USB devices might not work when connected through a combination of USB 2.0 Hi-Speed hubs and USB 1.1 full-speed or low-speed hubs. For example, you might not see an external USB hard disk on your desktop. To avoid this problem, do not connect USB devices with different speeds together. Connect your Hi-Speed hub directly to your computer and connect Hi-Speed devices to it. Connect a full-speed or low-speed hub to your computer directly and connect similar speed devices to it.

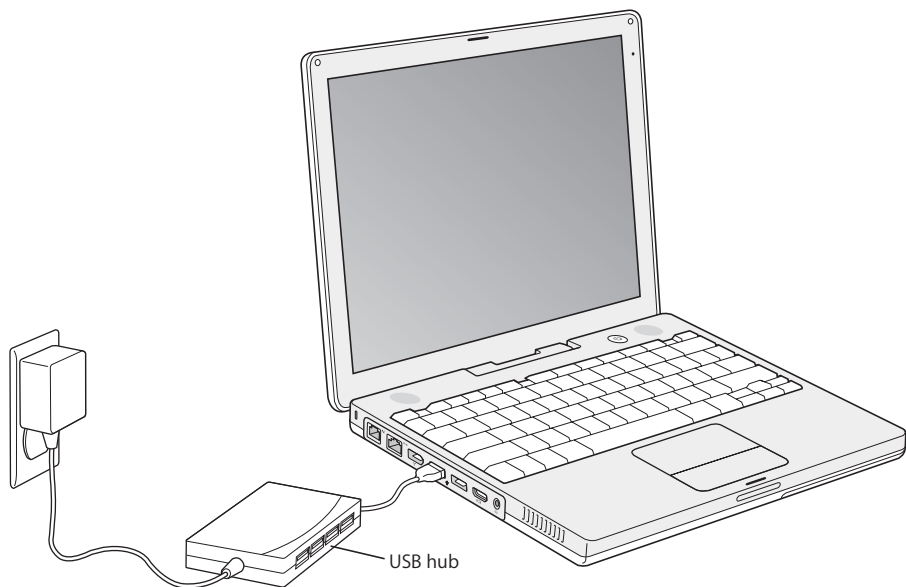

Getting More Information About USB

Additional information about USB is available in Mac Help. Choose Help > Mac Help in the menu bar and search for “USB.” You can also find information on the Apple USB website at www.apple.com/usb.

For information about USB devices available for your computer, check the Macintosh Products Guide at www.apple.com/guide.

Connecting With FireWire

Your computer has one FireWire 400 port (⌘). With FireWire, you can easily connect and disconnect external high-speed devices—such as digital video (DV) cameras, printers, scanners, and hard disks—without restarting your computer.

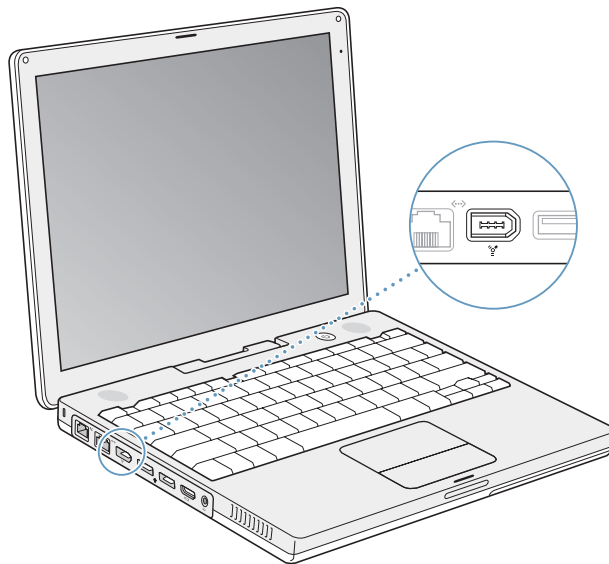

These are some of the things you can do with FireWire:

- Connect a DV camera and capture, transfer, and edit high-quality video directly on your computer using video-editing software such as iMovie HD or Final Cut Express.
- Connect an Apple iSight camera and use the included iChat AV application to videoconference with friends and family over a high-speed Internet connection.
- Connect an external FireWire hard disk drive and use it to back up data or transfer files.

- Start up from an external FireWire hard disk. Connect an external FireWire hard disk (with an operating system installed on it), open the Startup Disk pane of System Preferences, and click the FireWire hard disk. Restart your computer.
- Transfer files between your iBook and another FireWire-equipped computer using FireWire Target Disk Mode.

Using FireWire Devices

To use a FireWire device with your computer, connect the device to the computer. Apple has already included software to work with many FireWire devices. Your computer automatically detects newly connected devices.

Note: If your iBook cannot find the correct software when you connect a FireWire device, you can either install the software that came with the device or follow the onscreen prompts to use the Internet to locate, download, and install the correct software.

Understanding FireWire Devices and Battery Power

FireWire devices, such as certain external hard disk drives, can get power from the iBook FireWire connection instead of a separate power adapter. However, these types of FireWire devices can cause your iBook battery to become depleted faster. If a device will be connected for an extended period, it is a good idea to connect the iBook power adapter.

Note: The FireWire port (⌘) is designed to support power for FireWire devices (up to 7 watts maximum). You can connect multiple devices to each other and connect the “daisy chain” of devices to the FireWire port on your computer. Apple recommends that only one device get power from the computer. The rest of the devices in the daisy chain should be powered by separate power adapters. Connecting more than one FireWire device that gets power from the port may cause problems. If a problem occurs, shut down the computer, disconnect the FireWire devices, and restart your computer.

Connecting Your iBook G4 to Another Computer Using FireWire

If you want to transfer files between your iBook and another FireWire-equipped computer, or you have a problem that prevents your computer from starting up, you can use FireWire Target Disk Mode to connect to another computer. When you start up your iBook in FireWire Target Disk Mode, the other computer can access your iBook G4 as if it were a hard disk.

Note: When using FireWire Target Disk Mode, it’s a good idea to connect your power adapter to the iBook.

To connect your iBook G4 to another computer in FireWire Target Disk Mode:

- 1 Make sure that your iBook is shut down.
- 2 Use a FireWire cable to connect your iBook to another FireWire-equipped computer.
- 3 Start up your iBook and immediately hold down the T key.

Your iBook display shows the FireWire logo. The other computer's display shows the iBook internal hard disk icon. You can now drag and drop files between the systems.

- 4 When you finish transferring files, drag the iBook hard disk icon to the Trash.
- 5 Press the power button (⏻) on the iBook to shut it down, and then disconnect the FireWire cable.

Getting More Information About FireWire

Additional information about FireWire is available in Mac Help. Choose Help > Mac Help in the menu bar and search for "FireWire." You can also find information on the Apple FireWire website at www.apple.com/firewire.

Understanding AirPort Extreme Wireless Networking

Your iBook is AirPort-ready. AirPort Extreme offers an easy and affordable way to provide wireless Internet access anywhere in the home, at work, or in the classroom. Instead of using traditional cables, AirPort Extreme uses wireless local area network (LAN) technology to provide wireless communication between multiple computers. Through a wireless network you can set up access to the Internet, transfer files, play multiplayer games, and more.

The AirPort Extreme technology on your iBook is compatible with the Apple AirPort Extreme Base Station, AirPort Express, the original Apple AirPort Base Station, and 802.11b or 802.11g compliant products.

Note: Wireless Internet access requires an 802.11b or 802.11g access point such as an AirPort Extreme Base Station, AirPort Express, or AirPort Base Station, and Internet access (fees may apply). Some Internet service providers are not currently compatible with AirPort. Range may vary with site conditions.

Getting Wireless Internet Access With AirPort Extreme

With AirPort Extreme, you set up a wireless connection to a device known as a *base station*, which has a physical connection to the Internet. AirPort Extreme technology works like a cordless telephone. The AirPort Extreme technology in the computer makes a wireless connection to the AirPort Extreme or AirPort Express base station, which is connected to the phone line or a DSL or cable modem.

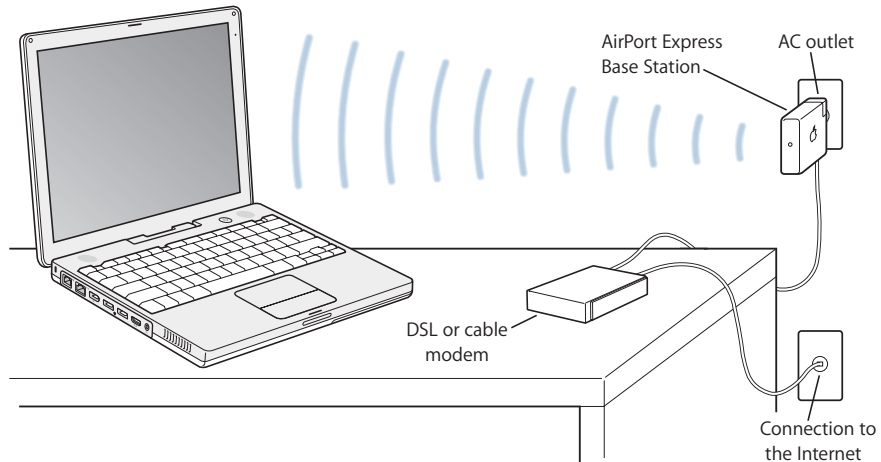

Getting More Information About AirPort Extreme

To purchase an AirPort Extreme Base Station or AirPort Express, contact your Apple Authorized Reseller or go to the online Apple Store at www.apple.com/store.

Additional information about AirPort Extreme or AirPort Express is available in AirPort Help. Choose Help > Mac Help, and then choose Library > AirPort Help from the Help Viewer menu bar. You can also find information on the Apple AirPort website at www.apple.com/airport or on the Apple Support website at www.apple.com/support.

Using Bluetooth Wireless Technology

Your iBook comes with Bluetooth wireless technology. With Bluetooth, you can make short-range wireless connections between desktop and portable computers, personal digital assistants (PDAs), mobile phones, camera phones, printers, digital cameras, and wireless input devices, such as the Apple Wireless Keyboard and Apple Wireless Mouse (available for purchase at www.apple.com/store).

Bluetooth wireless technology eliminates the need for many cables that traditionally connect devices together. Bluetooth enabled devices can connect to each other wirelessly at distances up to 33 feet (10 meters).

With Bluetooth wireless technology, you can do the following:

- Use your iBook to communicate with a compatible Bluetooth enabled mobile phone. Your phone can act as a modem to connect you to a wireless service provider, at speeds of up to 56 kilobits per second (kbit/s) or higher, so you can use your mobile phone to access the Internet.
- Communicate with your handheld Bluetooth enabled PDA. Using iSync, you can perform a hot sync operation without cables or send your business card or calendar events directly to a colleague's PDA.
- Exchange files between Bluetooth enabled computers and devices, even Mac to PC, using the transfer utility. Apple still recommends the use of AirPort Extreme wireless networking, however, for anything but the smallest files.
- Use a Bluetooth enabled wireless keyboard or mouse.
- Print to a Bluetooth enabled printer.
- Use a Bluetooth enabled headset.

Setting Up a Bluetooth Device

Before you can use a Bluetooth enabled device with your iBook, you need to set up the device to work with your computer. After you set up the device, it is “paired” with your computer, and you can see it in the Devices pane of Bluetooth preferences. You must pair your computer with the device only once, and they remain paired until you delete the pairing.

To set up a Bluetooth device:

- 1 Choose Bluetooth status menu (⌘) > Set up Bluetooth Device.
- 2 Follow the onscreen instructions for the type of device you want to set up.

Important: If the Bluetooth status menu (⌘) is not in the menu bar, open System Preferences and click Bluetooth. Click Settings and then select “Show Bluetooth status in the menu bar.”

To delete a pairing with a device:

- 1 Open System Preferences and click Bluetooth.
- 2 Click Devices and select the device from the list.
- 3 Click Delete.

Setting Up Bluetooth File Exchange

You can control how your computer handles files that are exchanged between it and other Bluetooth enabled devices. You can choose a folder for the files you accept from other devices, a folder for other devices to browse, and which applications to use to open the files you accept.

To set up Bluetooth file exchange:

- 1 Open System Preferences and click Bluetooth.
- 2 Click Sharing.
- 3 Select the On checkbox for Bluetooth File Exchange, and use the pop-up menus to adjust the settings.

Note: Select the “Require pairing for security” checkbox to secure File Exchange transactions and require password authentication before files can be transferred.

Sending a File to a Bluetooth Enabled Device

Your computer can wirelessly send files to other Bluetooth devices in range of your computer. If your computer is not paired with the device you want to send the file to, you might have to authenticate before you can send the file. If you have already paired your computer with the device, you might not have to enter a password again.

To send a file to a Bluetooth device:

- 1 Choose Bluetooth status menu (⌘) > Send File.
- 2 Select the file you want to send, and then click Send.
- 3 Select a device from the Device list, and then click Send.

Note: If the device is not in the Device list, click Search. When the device is found, you can add it to your Favorites list.

Use the File Exchange pane of Bluetooth preferences to set options for how your computer handles files exchanged with other Bluetooth devices.

Getting More Information About Bluetooth Wireless Technology

You can find out more about using Bluetooth wireless technology by opening the Bluetooth File Exchange application (located in the Utilities folder within the Applications folder) and choosing Help > Bluetooth Help. You can also find information on the Apple Bluetooth website at www.apple.com/bluetooth.

Connecting With Ethernet (10/100Base-T)

Your computer comes with built-in Ethernet networking capability, which you can use to connect to a network or to a cable or DSL modem.

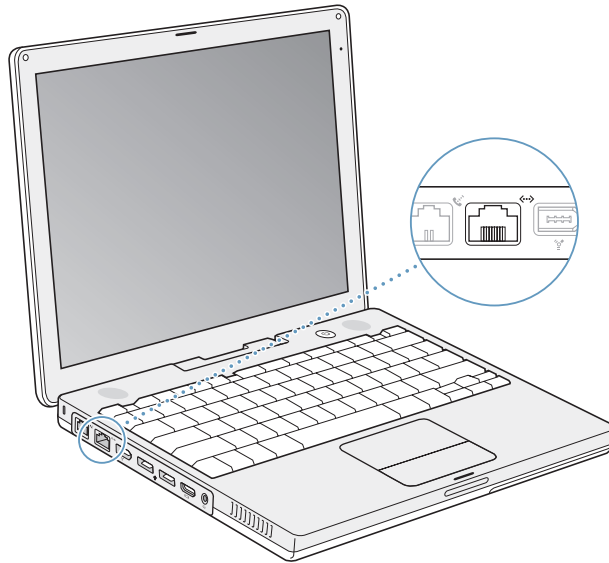

Connecting to a network gives you access to other computers. You may be able to store and retrieve information; use network printers, modems, and email; or connect to the Internet. You can use Ethernet to share files between two computers or set up a small network. You can also connect a cable modem or DSL modem to your Ethernet port to access the Internet using an Internet service provider (ISP). The Ethernet port on your iBook automatically detects other Ethernet devices. You don't need an Ethernet crossover cable when connecting to other Ethernet devices.

Getting More Information About Using Ethernet

Additional information, including setting up an Ethernet network and transferring files using Ethernet, is available in Mac Help. Choose Help > Mac Help from the menu bar and search for "Ethernet" or "network."

For information about networking products you can use with your iBook, check the Macintosh Products Guide at www.apple.com/guide.

Using Your Modem

Your iBook comes with an Apple 56K internal modem (V.92 compliant) installed. To connect the internal modem, plug one end of the phone cord or RJ-11 cable in to the modem port on your computer and the other end in to a standard RJ-11 telephone wall jack.

Make sure you connect the internal modem to an analog phone line—the kind typically used in homes. The modem will not work with a digital phone line.

Warning: Do not connect a digital phone line to the modem as it could damage the modem. Contact your telephone service provider if you are unsure whether you have a digital phone line.

For information about how to establish an Internet connection, see Appendix C, “Connecting to the Internet,” on page 75. More information about the internal modem is also available in Mac Help.

Using External Video Support (VGA, Composite, and S-Video)

Your computer has a video out port and an adapter that allow you to connect a display or projector with a VGA connector. Use the included Apple VGA Display Adapter to connect your iBook to monitors and projectors that have VGA output.

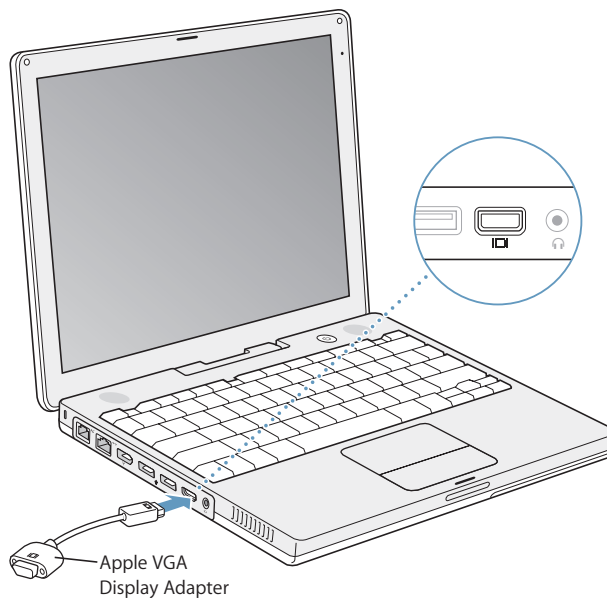

You can also display computer images by connecting a TV, video projector, or videocassette recorder (VCR)—or play DVD-Video discs on your TV—using an Apple Video Adapter, which is sold separately. The Apple Video Adapter provides composite and S-video connectors for TVs and other devices.

When an external monitor or TV is connected, the same image appears on both the internal display and the external monitor (known as *video mirroring*).

If you want sound to come from the external display, such as a projector or TV, you need to connect an audio cable from the computer's headphone (audio line out) port to that device.

Note: Because of the display limitations of most TVs, images displayed on the TV screen will be of lower quality than those on the built-in display or an external monitor.

Connecting an External Display or Projector

To connect an external display or projector with a VGA connector to your computer:

- 1 Turn on the external display or projector.
- 2 Connect the VGA display cable to the Apple VGA Display Adapter, and then connect the adapter to your iBook. Your iBook automatically detects the external display.

Important: To ensure that your iBook automatically detects the external display or projector, make sure the Apple VGA Display Adapter is plugged in to the external display or projector first.

Mac OS X automatically selects the display resolution and frequency appropriate for the device. You can adjust the resolution on an external display by using the Displays pane of System Preferences or by using the Displays icon in the menu bar.

Note: Your iBook doesn't support external display resolutions above 1024 x 768.

Connecting a TV, VCR, or Other Video Device

To connect a TV, VCR, or other video device to the iBook G4:

- 1 Connect an Apple Video Adapter (sold separately) to the composite or S-video connector of the TV or other device, and then connect the adapter to your iBook.
- 2 If you want to send the sound from your iBook to the device, connect a miniplug-to-RCA cable (not included) from the headphone port (🎧) on your iBook to the audio input ports on your device.
- 3 Turn on the external device.

To adjust how the images are displayed on the device, use the Displays pane of System Preferences.

Getting More Information About Using an External Monitor or TV

Additional information about using and configuring an external monitor is available in Mac Help. Choose Help > Mac Help from the menu bar and search for “external monitor.”

Connecting Speakers and Other Audio Devices

Your iBook comes with two built-in speakers, a built-in microphone, and a headphone (audio line out) port.

You can connect external speakers, headphones, and other sound output devices to the headphone port (🎧). The headphone port is a stereo 3.5 mini-phono jack.

You can record sound onto your hard disk using the built-in microphone. You can also connect external USB microphones or other audio equipment to the USB port. For applications that can record sounds, such as iMovie, use the Sound pane of System Preferences to select the audio input device you want to use.

The volume controls on your keyboard allow you to easily change volume. You can also access these controls from the Sound pane of System Preferences.

For more information about using or troubleshooting sound on your computer, choose Help > Mac Help from the menu bar and search for “sound.”

Using Your Optical Drive

You can install or use software from CDs and from DVDs using your Combo or SuperDrive. You can play multimedia on CD discs and music from audio CDs; play DVD movies; and write music, documents, and other digital files to CD-R and CD-RW discs. If you have a SuperDrive, you can record DVD movies and other information on DVD-R discs.

Important: The optical drive on your iBook supports standard circular 12 cm discs. Irregularly shaped discs or discs smaller than 12 cm are not supported. Noncircular discs can become lodged in the drive.

Inserting a CD or DVD Disc

To install or use programs from a CD or DVD disc:

- 1 With the computer turned on, insert the disc (with the label facing up) in to the drive slot until you feel the drive catch the disc and take it the rest of the way in.

You might need to insert the disc nearly all the way in before the drive takes it the rest of the way. This is normal.

Note: Some DVD discs are two-sided. Your optical drive can read both sides of a two-sided disc.

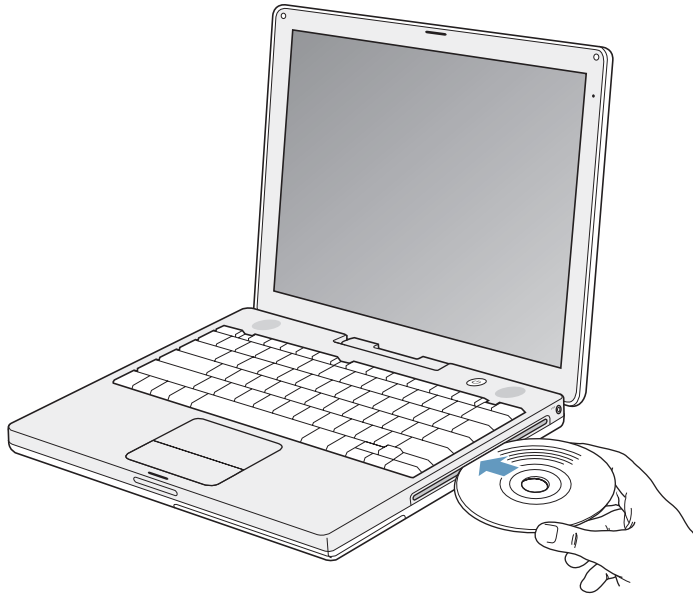

- 2 When the icon for the disc appears on the desktop, the disc is ready to use.

Ejecting a Disc

To eject a disc, do one of the following:

- Drag the disc icon to the Trash.
- Press and hold the Media Eject key (⏏) on the keyboard until the disc ejects.

Allow the disc to fully eject before removing or reinserting it.

If you can't eject the disc, quit any applications that might be using the disc and try again. If that doesn't work, restart the computer while holding down the trackpad button.

Playing DVDs

To play a digital video disc (DVD) on your iBook, insert the DVD. DVD Player opens automatically. You'll find DVD Player provides easy-to-use controls for starting, stopping, and viewing DVDs.



If your iBook is connected to a TV, you can watch a DVD on the TV screen. You can also connect your iBook to your stereo system. Use a miniplug-to-RCA cable (not included) to connect the headphone port (🎧) on your iBook to the audio input ports on your stereo.

Recording CD-R and CD-RW Discs

Your iBook can record data to CD-R and CD-RW discs.

To record data on a CD-R or CD-RW disc:

- 1 Insert a blank disc in to the optical drive.
- 2 In the dialog that appears, enter a name for the disc. An icon for the disc appears on the desktop.
- 3 Drag files and folders to the disc icon.
- 4 Click the Burn Disc icon beside the disc name in the Finder sidebar.

You can also record music to CD-R or CD-RW discs right from your iTunes library.

To record music from your iTunes library:

- 1 Click the iTunes icon in the Dock.
- 2 Select the playlist you want to record.
- 3 Insert a blank CD-R or CD-RW disc.
- 4 At the top of the iTunes window, click Burn CD.

Important: If your battery runs down when you are burning a CD, the burn can fail and you will not be able to use the CD disc again. To avoid this, always use your power adapter when burning a CD.

Recording Information on a DVD

If you have a SuperDrive, you can record your own digital movies on a blank recordable DVD disc. You can also record other kinds of digital data. For example, you can back up files to recordable DVD discs.

With your SuperDrive, you can:

- Install or use software from CDs or DVDs.
- Play music and multimedia files from CDs.
- Write music, documents, and other digital files to CD-R and CD-RW discs.
- Play DVD movies and read most DVD discs.
- Record information on blank DVD-R, DVD+R, DVD-RW, and DVD+RW discs.

Important: The SuperDrive in your iBook supports standard circular 12 cm discs. Irregularly shaped discs or discs smaller than 12 cm are not supported. Noncircular discs can become lodged in the drive.

With iDVD, you can create your own customized digital media project, burn it on a blank recordable DVD disc, and play it on most standard DVD players.

To burn an iDVD project onto a blank DVD-R disc:

- 1 Open iDVD and open your completed iDVD project.
- 2 Click the Burn button.
- 3 When prompted, insert a blank recordable DVD disc in to the drive.
- 4 Click the Burn button again.

Note: Although the SuperDrive can read both sides of a two-sided DVD-R disc, it can only record on a single side.

To record data on DVD-R discs:

- 1 Insert a blank recordable DVD disc in to the drive.
- 2 In the dialog that appears, enter a name for the disc and select the format you want to use.
- 3 Double-click the DVD icon that appears on your desktop, and then drag files and folders to it.
- 4 Click the Burn Disc icon beside the disc name in the Finder sidebar.

For more information about how to use iDVD, open iDVD and choose Help > iDVD Help.

Important: If your battery runs down when you are burning a DVD, the burn can fail and you will not be able to use the DVD disc again. To avoid this, always use your power adapter when burning a DVD.

Getting More Information

- For instructions on using DVD Player, choose Help > DVD Player Help from the menu bar at the top of the screen.
- For information about using iTunes to record music files on a CD-R or CD-RW disc, choose Help > “iTunes and Music Store Help” from within iTunes.

Understanding Sudden Motion Sensor

Your iBook has Sudden Motion Sensor technology, built-in protection for the hard disk that is designed to help prevent disk failures if the computer is dropped or experiences severe vibration.

In general, Sudden Motion Sensor protection does not change hard disk performance during regular iBook operation. Occasionally, unusually strong vibrations might activate the Sudden Motion Sensor technology at a time when your iBook is writing or reading data intensively (such as when you are playing or recording video or audio). If you notice dropped frames or sound elements, make sure that your iBook is in a stable environment without vibration or abrupt movement.

Using Your Battery

When the external power adapter is not connected, your computer draws power from its battery. The length of time that you can run your iBook off one battery charge varies, depending on the applications you use and external devices connected to your iBook. Turning off features such as AirPort Extreme or Bluetooth wireless technology when not in use can help to conserve battery charge. For more information about using your battery, see “Charging a Battery” on page 49.

You can determine the charge left in your battery by looking at the battery level indicator lights on the battery itself. Press the button next to the lights, and the lights glow to show how much charge is left in the battery. The indicator lights remain lit for a few seconds after you press the button. You can check the charge with the battery in or out of the iBook.

If your battery runs low while you are working, attach your power adapter and let the battery recharge. If you want to replace the battery with a charged one, attach the power adapter, shut down your iBook, and replace the battery. If you replace the battery without the power adapter attached, you can lose information and settings such as the date and time.

Important: If only one flashing light is on, very little charge is left. If no lights are visible, the battery is completely drained and the computer will not start up unless the power adapter is connected. Plug in the power adapter for several hours to let the battery recharge, or replace the drained battery with a fully charged battery (see the next section).

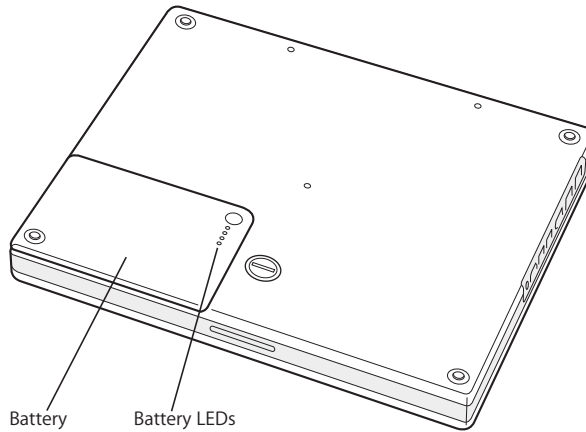

Removing and Replacing the Battery

To remove the battery:

- 1 Shut down your iBook. Disconnect the power adapter, phone cord, and any other cables connected to the computer to prevent damaging the computer.
- 2 Turn over the iBook and locate the battery latch. Use a coin to turn the latch a quarter turn clockwise to unlock the battery, and gently remove it.

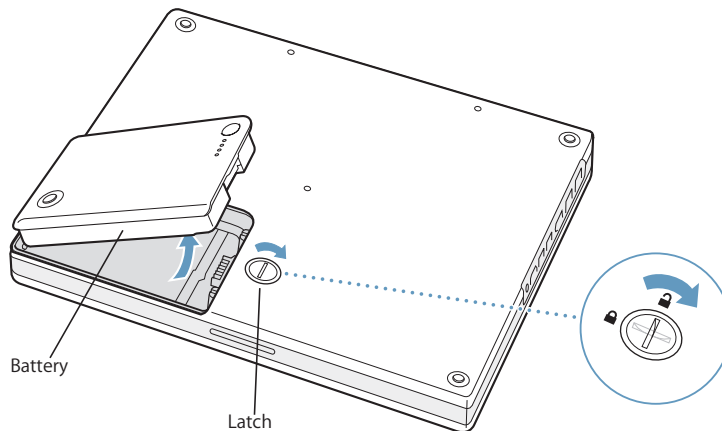

To replace the battery:

- Place the left side of the battery in to the battery compartment. Gently press the right side of the battery down until the battery latch locks.

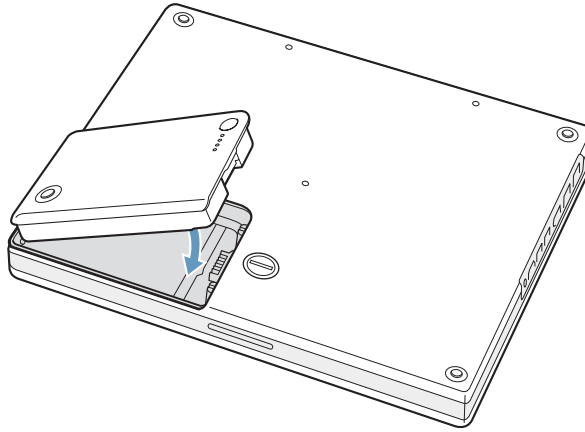

Note: Dispose of batteries according to your local environmental laws and guidelines. For more information, see “Disposal and Recycling Information” on page 96.

Charging a Battery

When the power adapter that came with your computer is connected, the battery recharges whether the computer is off, on, or in sleep. However, the battery recharges more quickly if the computer is off or in sleep. When the computer is on, you can monitor the battery charge level using the Battery status icon in the menu bar.

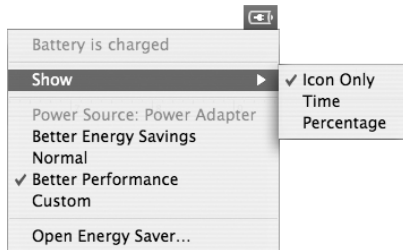

The battery charge level displayed is based on the amount of power left in the battery with the applications, peripheral devices, and system settings (display brightness, Energy Saver settings, and so on) you are currently using. To make more battery power available, close applications and disconnect peripheral devices not in use, and adjust your Energy Saver settings (see the next section).

Understanding Battery Conservation Tips

For the best conservation of battery power, do the following:

- Disconnect USB or FireWire devices when they are not in use.
- Quit open applications that you are not using.
- Turn off AirPort or Bluetooth when they are not in use. (Use the AirPort and Bluetooth status icons in the menu bar. If these icons don't appear in the menu bar, you can turn them on in the Network and Bluetooth panes of System Preferences.)
- Remove CD and DVD discs when they are not in use.
- Reduce screen brightness using the brightness controls on the iBook keyboard.
- Set the hard disk to spin down after a short time. In the Energy Saver pane of System Preferences, select the "Put the hard disk to sleep when possible" option.
- Set your iBook to sleep after inactivity of five minutes or less.

To further save battery power, select the following options in the Energy Saver pane of System Preferences:

- Set your computer to modify its processor speed based upon the required amount of processing activity. In the Energy Saver pane of System Preferences, click Show Details to see the settings. Choose Battery Power from the "Settings for" pop-up menu, click Options, and choose Automatic from the Processor Performance pop-up menu. (To set your computer to use its highest processing speed at all times, choose Highest from the Processor Performance pop-up menu.)
- To conserve battery life the longest, choose Better Battery Life from the Optimization pop-up menu. Be aware that choosing this option will adversely affect your applications' performance.

Getting More Information About Your iBook G4 Battery

Additional information is available in Mac Help. Choose Help > Mac Help from the menu bar and search for "battery." You can also find information on the Apple batteries website at www.apple.com/batteries.

Securing Your iBook G4

You can purchase a security cable lock to protect your iBook. With a lock, you can secure your computer to a desk or table.

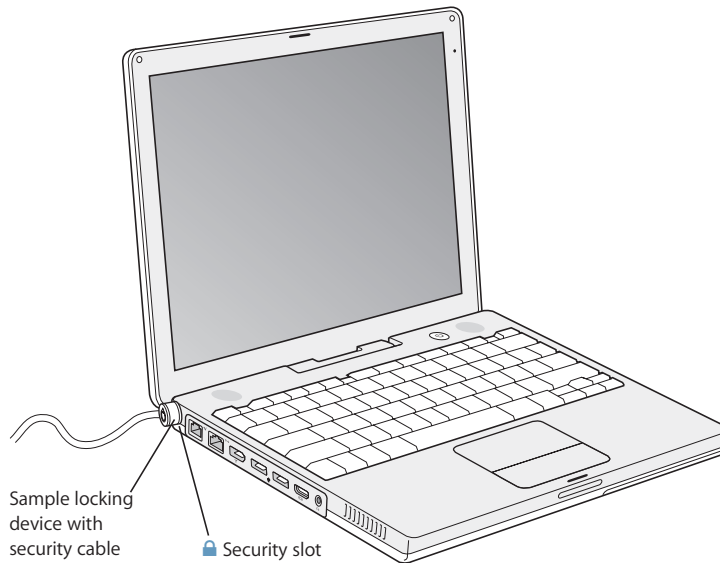

Getting More Information About Security Options

Additional information about the software security features of your iBook, including multiple user passwords and file encryption, is available in Mac Help. Choose Help > Mac Help from the menu bar and search for “security” or “multiple users.”

This chapter provides information and instructions for installing additional memory in your iBook G4.

Warning: Apple recommends that you have an Apple-certified technician install memory. Consult the service and support information that came with your computer for instructions on how to contact Apple for service. If you attempt to install memory and damage your equipment, such damage is not covered by the limited warranty on your computer.

Your computer comes with one memory slot that you access by removing the computer's keyboard. Your computer also comes with 512 megabytes (MB) of Double Data Rate (DDR) Synchronous Dynamic Random-Access Memory (SDRAM) already installed on the logic board.

The memory slot can accept an SDRAM module that meets the following specifications:

- Double Data Rate Small Outline Dual Inline Memory Module (DDR SO-DIMM) format
- 1.25 inch or smaller
- 128, 256, 512 MB, or 1 gigabyte (GB)
- 200-pin
- PC2700 DDR 333 Type RAM for the 14-inch iBook G4
- A minimum of PC2100 DDR 266 Type RAM for the 12-inch iBook G4. You can use PC2700 DDR 333 Type RAM with the 12-inch iBook G4, but it will still run at PC2100 DDR 266 speed.

The recommended maximum amount of memory you can install in your iBook is 1.5 GB, using one 1 GB DIMM in the memory slot.

Installing Additional Memory

To install additional memory in your iBook, you must:

- Remove the battery and keyboard.
- Install the memory.
- Replace the keyboard and battery.

These tasks are described in the following pages.

Step 1: Removing the Battery and Keyboard

- 1 Shut down your iBook. Disconnect the power adapter, phone cord, and any other cables connected to the computer to prevent damaging the computer.
- 2 Turn over the iBook and locate the battery latch. Use a coin to turn the latch a quarter turn clockwise to unlock the battery, and gently remove it.

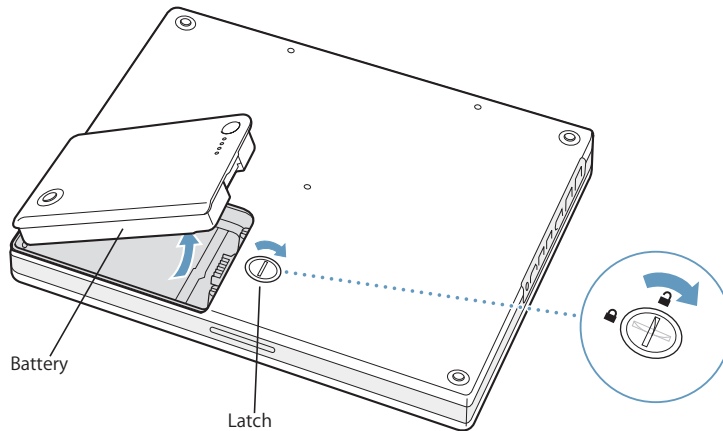

Warning: The internal components of your iBook might be hot. If you have been using your iBook, wait 30 minutes after shutting down to let the internal components cool before continuing.

- 3 Release the keyboard by sliding the two plastic tabs away from the display. Then lift the keyboard, flip it over, and lay it on the palm rest.

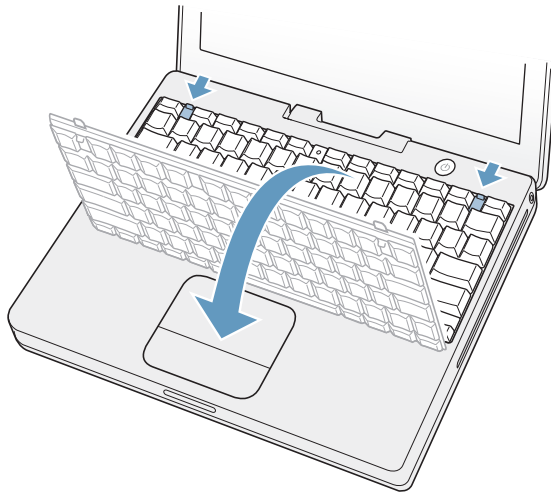

If the keyboard doesn't pop up, it might be locked. Locate the plastic tab next to the Num Lock key. Use a small flathead screwdriver to turn the screw one half turn.

- 4 Touch a metal surface inside the computer to discharge any static electricity from your body.

Step 2: Installing Memory

- 1 Loosen the four captive screws that secure the RAM shield, and then carefully lift it out.

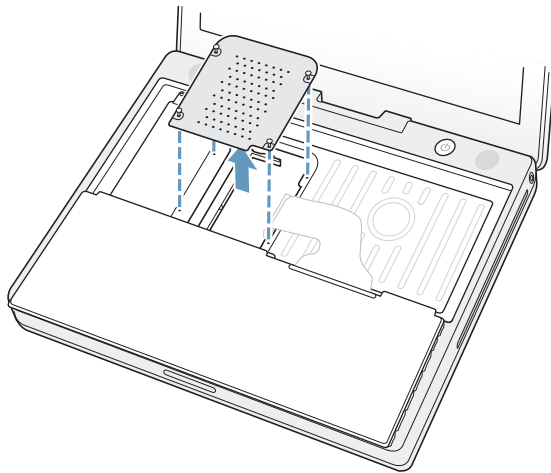

- 2 If you already have a memory card installed in the slot, remove it. Spread the tabs in the slot away from the notches in the memory card. The card should pop up slightly.

- 3 Insert the new memory card in to the slot at a 30-degree angle. Push the card to seat it fully in to the slot.

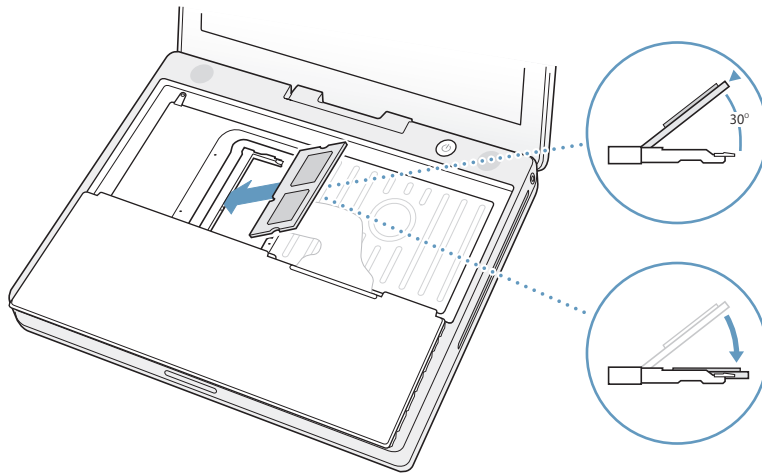

- 4 Press down on the memory card to lock it in place.
If the memory card does not latch, do not force it down. Try reinserting the card to make sure it is fully seated.
- 5 Replace the RAM shield.

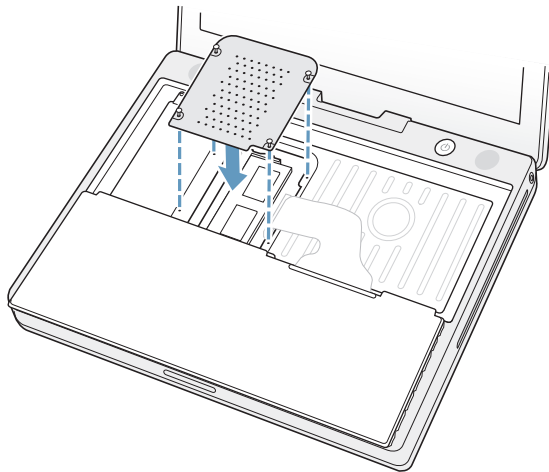

Now that you're done installing the memory card, proceed to the next section and "Making Sure Your iBook G4 Recognizes the New Memory" on page 59.

Step 3: Replacing the Keyboard and Battery

- 1 Replace the keyboard by inserting it at an angle and gently lowering it in to place.

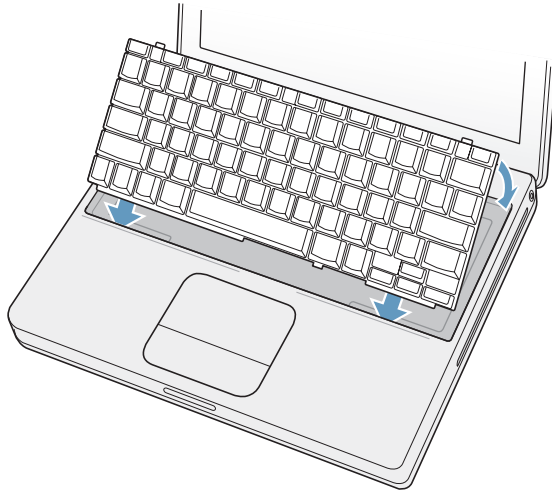

- 2 To discourage unauthorized access to your memory module, you can lock the keyboard by turning the keyboard screw one half turn clockwise.

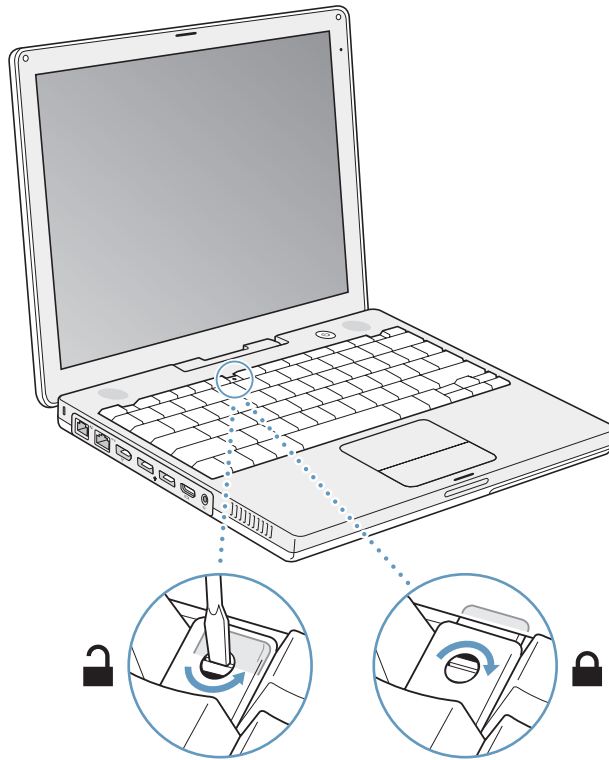

- 3 Replace the battery. Place the left side of the battery in to the battery compartment. Gently press the right side of the battery down until the battery latch locks in to place.

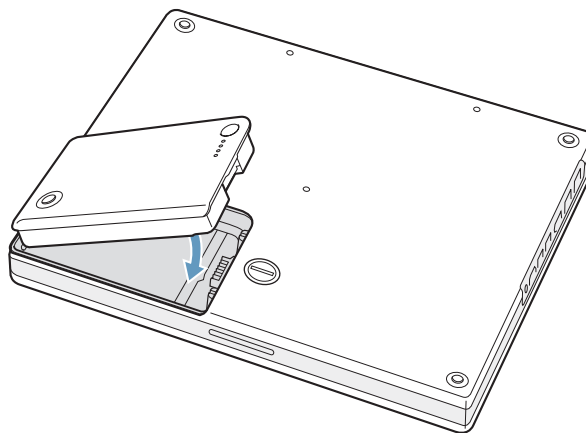

- 4 Reconnect the power adapter and any other cables that were attached.

Making Sure Your iBook G4 Recognizes the New Memory

After installing additional memory in your iBook, check whether the computer recognizes the new memory.

- 1 Start up your computer.
- 2 When you see the Mac OS desktop, choose Apple () > About This Mac.

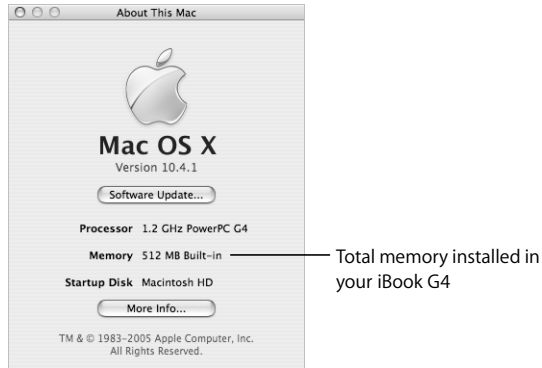

The total memory includes the amount that originally came with the computer plus the new memory you added. For a detailed breakdown of the memory installed in your computer, open System Profiler by clicking More Info.

If the memory is not recognized or your computer does not start up correctly, shut down your iBook and check the instructions again to make sure that the memory you installed is compatible with your iBook and that it is installed correctly. If you still have problems, remove the memory and consult the support information that came with the memory or contact the vendor who provided the memory.

If you have a problem working with your iBook G4, check here first for solutions and advice.

When you experience a problem working with your iBook, there is usually a simple and quick solution. Be aware of the conditions that led up to the problem. Making a note of steps you took before the problem occurred will help you narrow down possible causes and find the answers you need.

Note the following:

- The applications you were using when the problem occurred. Problems that occur only with a specific application can indicate that the application is not compatible with the version of the Mac OS installed on your computer.
- Any software that you recently installed, especially software that added items to the System folder. (Certain applications install extensions that might not be compatible with the Classic environment.)
- Any new hardware that you installed, such as additional memory or a peripheral.

You can also find more troubleshooting information in Mac Help and on the Apple Service & Support website at www.apple.com/support.

Problems That Prevent You From Using Your Computer

If the computer doesn't respond or the pointer doesn't move

- Press Command (⌘)-Option-Esc to force a frozen application to quit. If a dialog appears, select the application you want to quit and click Force Quit. If you are working in the Classic environment, hold down the Option and Command (⌘) keys and then press the Esc key.

Next, save your work in any open applications and restart the computer to make sure the problem is entirely cleared up.

- If you are unable to force the application to quit, press and hold the power button (⏻) for a few seconds to shut down the computer.

- If the computer still doesn't respond, try to restart it by simultaneously pressing the Command (⌘) and Control keys on your keyboard and the power button (⏻).

If the problem occurs frequently, choose Help > Mac Help from the menu bar at the top of the screen. Search for the word "freeze" to get help for instances when the computer freezes or doesn't respond.

If the problem occurs only when you use a particular application, check with the application's manufacturer to see if it is compatible with your computer. If you know an application is compatible, you might need to reinstall your computer's system software or, if you're using the Classic environment, you might need to check for incompatible system extensions. See the next topic for instructions.

If the computer freezes during startup or you see a flashing question mark

- Wait a few seconds. If the computer doesn't start up after a delay, shut down your computer by pressing and holding the power button (⏻) for about 5 seconds, until the computer shuts down. Then hold down the Option key and press the power button (⏻) again to start up your computer. When your computer starts up, click the hard disk icon, and then click the right arrow. After the computer starts up, open System Preferences and click Startup Disk. Select a local Mac OS X System folder.
- If that doesn't work, try using Disk Utility to repair the disk by inserting the Mac OS X Install Disc 1 in to your computer. Then restart your computer and hold down the C key as it starts up. Choose Installer > Open Disk Utility. When Disk Utility opens, follow the instructions in the First Aid pane to see if the utility can repair your disk. If using Disk Utility doesn't work, you might need to reinstall your computer's system software. For instructions, see "Reinstalling the Software That Came With Your Computer" on page 65.

If the computer doesn't turn on or start up

- Make sure the power adapter is plugged in to the computer and in to a functioning power outlet. Make sure to use the power adapter that came with your computer.
- Check if your battery needs to be recharged. Press the small button on the battery (see page 47). You should see one to four lights indicating the battery's level of charge. If only one battery level indicator light is flashing, allow the power adapter to charge the battery until at least one indicator light is glowing continuously.
- If that does not work, press the power button (⏻) and immediately hold down the Command (⌘), Option, P, and R keys until you hear the startup sound a second time.
- If you recently installed additional memory, make sure that it is correctly installed and that it is compatible with your computer. See whether removing it allows the computer to start up (see "Installing Memory" on page 55).
- If you are still unable to start up your computer, see the service and support information that came with your iBook for information about contacting Apple for service.

If the display suddenly goes black or your system freezes

Try restarting your system.

To restart your iBook G4:

- 1 Unplug any devices that are connected to your iBook except the power adapter.
- 2 Hold down the Command (⌘) and Control keys and press the power button (⏻) to restart the system.
- 3 Let the battery charge to at least 10 percent before plugging in any external devices and resuming your work.

To see how much the battery has recharged, look at the Battery status icon in the menu bar.

Other Problems

If you forgot your password

You can reset your administrator password.

To reset your password:

- 1 Insert your Mac OS X Install Disc 1. Then restart your computer and hold down the C key as it starts up.
- 2 Choose Installer > Reset Password from the menu bar. Follow the instructions on the screen.

If you have a problem with an application

- For problems with software from a manufacturer other than Apple, contact the manufacturer. Software manufacturers often provide software updates on their websites.
- You can configure your iBook to automatically check for and install the latest Apple software using the Software Update pane of System Preferences. For more information, choose Help > Mac Help from the menu bar and search for “Software Update.”

If you have trouble using AirPort Extreme Wireless Communication

- Make sure you have properly configured the software according to the instructions that came with your computer or in Mac Help.
- Make sure the computer or network you are trying to connect to is running and has a wireless access point.
- Make sure you are within antenna range of the other computer or the network’s access point.

Nearby electronic devices or metal structures can interfere with wireless communication and reduce this range. Repositioning or rotating the computer might improve reception.

- Check the AirPort Extreme or AirPort Express signal level.
Check the AirPort status icon in the menu bar. Up to four bars appear to show signal strength.
- See AirPort Help (choose Help > Mac Help, then choose Library > AirPort Help from the menu bar) and the instructions that came with the wireless device for more information.

If you have trouble ejecting a disc

- Quit any applications that might be using the disc and try again. If that doesn't work, restart the computer while holding down the trackpad button.

If you have problems with your Internet connection

- Make sure your phone line or network cable is connected and functioning properly.
- If you are using a dial-up Internet connection, make sure that your phone cord is plugged in to the modem port (📞) and not the Ethernet port (🌐) on the computer.
- Open the Network pane of System Preferences and verify the information entered there with your Internet service provider (ISP) or network administrator.

If you have a problem using your computer or working with the Mac OS

- If the answers to your questions are not in this manual, choose Help > Mac Help from the menu bar and search for instructions and troubleshooting information.
- Check the Apple Service & Support website at www.apple.com/support for the latest troubleshooting information and software updates.

Using Apple Hardware Test

If you suspect a problem with your computer hardware, you can use the Apple Hardware Test application to help determine if there is a problem with one of your computer's components, such as the memory or processor.

To use Apple Hardware Test:

- 1 Disconnect all external devices from your computer except the keyboard and mouse. If you have an Ethernet cable connected, disconnect it.
- 2 Insert the Mac OS X Install Disc 1 that came with your computer.
- 3 Restart your computer and hold down the Option key as it starts up.
A list of available startup volumes appears.
- 4 Click Apple Hardware Test and click the right arrow.
- 5 Follow the onscreen instructions when the Apple Hardware Test main screen appears (after about 45 seconds).
- 6 If Apple Hardware Test detects a problem, it displays an error code. Make a note of the error code before pursuing support options. If Apple Hardware Test does not detect a hardware failure, the problem may be software related.

For more information about Apple Hardware Test, see the Apple Hardware Test Read Me file on the Mac OS X Install Disc 1.

Reinstalling the Software That Came With Your Computer

Use the software install discs that came with your computer to reinstall Mac OS X and the applications that came with your computer, and to install Mac OS 9 support for running the Classic environment (if you want to use Classic applications on your computer).

Important: Apple recommends that you back up the data on your hard disk before restoring software. Apple is not responsible for any lost data.

Installing Mac OS X and Applications

To install Mac OS X and the applications that came with your computers:

- 1 Back up your essential files.
Because the Erase and Install option erases your destination disk, you should back up your essential files before installing Mac OS X and other applications.
- 2 Make sure your power adapter is plugged in.
- 3 Insert the Mac OS X Install Disc 1 that came with your computer.
- 4 Double-click Install Mac OS X and Bundled Software.
- 5 Follow the onscreen instructions.
- 6 After selecting the destination disk for installation, continue following the onscreen instructions. Your computer might restart and ask you to insert the next Mac OS X install disc.

Note: To restore Mac OS X on your computer to the original factory settings, click Options in the Select a Destination pane of the Installer, and then select Erase and Install.

After selecting the destination disk for installation, continue following the onscreen instructions for a basic installation of Mac OS X. To install custom applications, click Customize, click the triangle next to the application, and select the application that matches your language.

Installing Applications

Your computer must have Mac OS X already installed before you can install applications.

To install just the applications that came with your computer:

- 1 Back up your essential files.
- 2 Make sure your power adapter is plugged in.
- 3 Insert the Mac OS X Install Disc 1 that came with your computer.
- 4 Double-click Install Bundled Software Only.
- 5 Follow the onscreen instructions.
- 6 After selecting the destination disk for installation, continue following the onscreen instructions. Your computer might restart and ask you to insert the next Mac OS X install disc.

Note: To install iCal, iChat AV, iSync, Safari, and the iLife applications, follow the instructions in “Installing Mac OS X and Applications” on page 65. You might need to insert Mac OS X Install Disc 2, depending on the applications you select to install.

Installing Mac OS 9

Your iBook does not come with Mac OS 9 installed. To use Classic applications with your computer, you must install Mac OS 9 support for running the Classic environment using the Mac OS X Install Disc 2.

To install Mac OS 9 support:

- 1 Back up your essential files.
- 2 Make sure your power adapter is plugged in.
- 3 Insert the Mac OS X Install Disc 2 that came with your computer.
- 4 Double-click Install Mac OS 9 System Support.
- 5 Follow the onscreen instructions.
- 6 After selecting the destination disk for installation, continue following the onscreen instructions.

Locating Your Product Serial Number

You can see your computer's serial number by choosing Apple (🍏) > About This Mac and then clicking the More Info button, or by opening System Profiler (in Applications/Utilities) and clicking Hardware. The serial number for your iBook is also located under the keyboard. For instructions on removing the keyboard, see “Removing the Battery and Keyboard” on page 54.

You can use System Profiler to find out detailed information about your iBook G4, such as the amount of built-in memory, hard disk size, devices connected, and the product serial number.

To access the information in System Profiler, choose Apple () > About This Mac from the menu bar and then click More Info, or open System Profiler, located in Applications/Utilities.

Click the triangles in the window to show and hide information in the different categories.

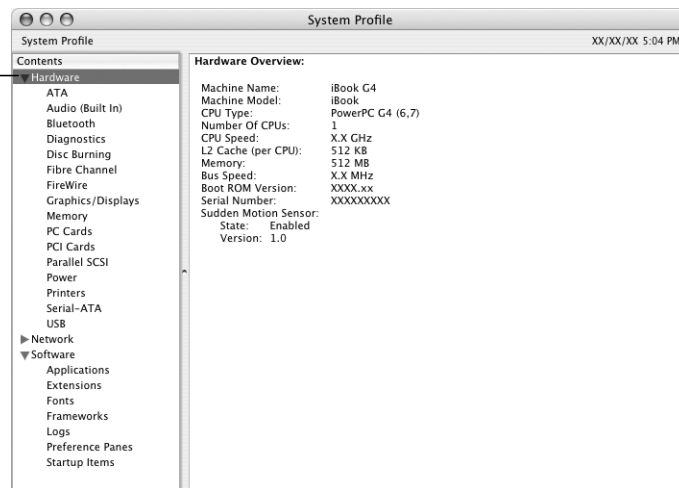

Operating Environment

- *Operating temperature:* 50° F to 95° F (10° C to 35° C)
- *Altitude:* 3048 m (10,000 ft.) maximum
- *Relative humidity:* 20% to 80% noncondensing

Power Adapter

- *Input:* AC 100–240 volts (V), 50/60 hertz (Hz)
- *Output:* DC 24.5 V, 1.875 A

Battery

- *Output:* DC 10.8 V for 12-inch iBook G4, 14.4 V for 14-inch iBook G4
- *Capacity:* 50 Wh for 12-inch iBook G4, 61 Wh for 14-inch iBook G4

Additional information is available on the Apple website at www.apple.com/ibook and www.apple.com/support.

Read this important iBook G4 safety and maintenance information.

Cleaning Your iBook G4

Follow these general rules when cleaning the outside of your computer and its components:

- Shut down your iBook, disconnect the power adapter and modem cable, and remove the battery.
- Use a damp, soft, lint-free cloth to clean the computer's exterior. Avoid getting moisture in any openings. Do not spray liquid directly on the computer.
- Don't use aerosol sprays, solvents, or abrasives.

Cleaning Your iBook G4 Display

To clean your iBook screen, do the following:

- Shut down your iBook, disconnect the power adapter and modem cable, and remove the battery.
- Dampen a clean, soft, lint-free cloth or paper with water only and wipe the screen. Do not spray liquid directly on the screen.

Carrying Your iBook G4

If you carry your iBook in a bag or briefcase, make sure that there are no loose items (for example, paper clips or coins) that could accidentally get inside the computer through an opening such as the optical drive slot.

Storing Your iBook G4

If you are going to store your iBook for a period of time, do one of the following to prevent your iBook battery from becoming completely depleted:

- Keep the power adapter connected.
- For short-term storage, fully charge your iBook battery and store the computer in a cool, climate-controlled location.
- For long-term storage of six months or longer, charge your battery approximately halfway (50 percent) and then remove your iBook battery.

Safety Instructions for Setting Up and Using Your iBook G4

Be aware of the following safety tips and warnings as you work with your iBook.

Plugging In the Power Adapter

Always leave space around your power adapter. Do not use this equipment in a location where airflow around the power adapter or computer is confined. Always disconnect the power adapter and remove the battery before opening the computer to perform procedures such as installing memory.

Warning: Use only the power adapter that came with your iBook G4 computer. Adapters for other electronic devices (including other iBook models and other portable computers) might look similar, but they can negatively affect your computer's performance or damage your computer.

Connecting a Phone Line to the Internal Modem

Always disconnect the phone cord before opening the computer to perform procedures such as installing memory.

Warning: Do not connect a digital phone line to the modem; the wrong type of line could damage the modem. Contact your telephone service provider if you are unsure whether you have a digital phone line.

Using Connectors and Ports

Never force a connector in to a port. If the connector and port don't join with reasonable ease, they probably don't match. Make sure that the connector matches the port and that you have positioned the connector correctly in relation to the port.

Using Your iBook G4

When you use your iBook or charge its battery, it is normal for the bottom of the case to get warm. For prolonged use, place your iBook on a flat, stable surface. The bottom of the iBook case functions as a cooling surface that transfers heat from inside the computer to the cooler air outside. The bottom of the case is raised slightly to allow airflow that keeps the unit within normal operating temperatures. In addition, the computer vents warm air from the back of the case.

Warning: Do not place your iBook on a pillow or other soft material when it is on, because the material can block the airflow vents, in particular the rear vents, and cause the computer to overheat. Never place anything over your keyboard before closing the display. This can cause your computer to cycle on and off, which may create excessive heat and drain your battery. Never turn on your computer unless all of its internal and external parts are in place. Operating the computer when it is open or missing parts can be dangerous and can damage your computer.

Understanding General Safety Instructions

For your own safety and that of your equipment, always take the following precautions.

Disconnect the power plug (by pulling the plug, not the cord), remove the battery, and disconnect the phone cord if any of the following conditions exists:

- You want to remove any parts.
- The power cord or plug becomes frayed or otherwise damaged.
- You spill something in the case.
- Your computer is exposed to rain or any other excess moisture.
- Your computer has been dropped or the case has been otherwise damaged.
- You suspect that your computer needs service or repair.
- You want to clean the case (use only the recommended procedure described earlier).

Important: The only way to disconnect power completely is to unplug the power cord and phone cord, and remove the battery. Make sure at least one end of the power cord is within easy reach so that you can unplug the computer when you need to.

Warning: Your AC cord came equipped with a three-wire grounding plug (a plug that has a third grounding pin). This plug will fit only a grounded AC outlet. If you are unable to insert the plug in to an outlet because the outlet is not grounded, use the AC plug that came with your adapter, or contact a licensed electrician to replace the outlet with a properly grounded outlet. Do not defeat the purpose of the grounding plug.

Make sure that you always do the following:

- Keep your computer away from sources of liquids, such as drinks, washbasins, bathtubs, shower stalls, and so on.
- Protect your computer from dampness or wet weather, such as rain, snow, and so on.
- Read all the installation instructions carefully before you plug your computer in to a wall socket.
- Keep these instructions handy for reference by you and others.
- Follow all instructions and warnings about your system.

Important: Electrical equipment can be hazardous if misused. Operation of this product, or similar products, must always be supervised by an adult. Do not allow children access to the interior of any electrical product and do not permit them to handle any cables.

Warning: Never push objects of any kind in to this product through the openings in the case. Doing so can be dangerous and may result in fire or electric shock.

Handling the Battery

Warning: There is risk of explosion if the battery is replaced by an incorrect type. Dispose of used batteries according to your local environmental guidelines. Don't puncture or incinerate the battery.

Avoiding Hearing Damage

Warning: Permanent hearing loss may occur if earbuds or headphones are used at high volume. You can adapt over time to a higher volume of sound, which might sound normal but can be damaging to your hearing. Set your iBook volume to a safe level before that happens. If you experience ringing in your ears, reduce the volume or discontinue use of earbuds or headphones with your iBook.

Understanding Ergonomics

Here are some tips for setting up a healthy work environment.

Keyboard and Trackpad

When you use the keyboard and trackpad, your shoulders should be relaxed. Your upper arm and forearm should form an angle that is slightly greater than a right angle, with your wrist and hand in roughly a straight line.

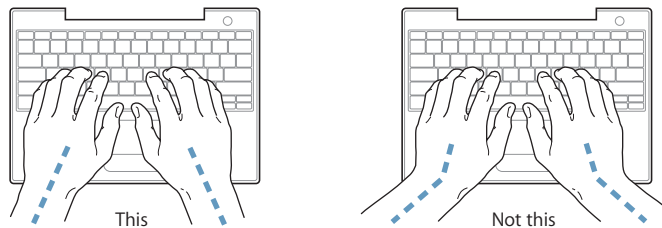

Use a light touch when typing or using the trackpad and keep your hands and fingers relaxed. Avoid rolling your thumbs under your palms.

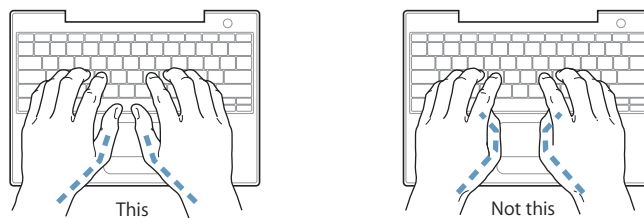

Change hand positions often to avoid fatigue. Some computer users might develop discomfort in their hands, wrists, or arms after intensive work without breaks. If you begin to develop chronic pain or discomfort in your hands, wrists, or arms, consult a qualified health specialist.

Chair

An adjustable chair that provides firm, comfortable support is best. Adjust the height of the chair so your thighs are horizontal and your feet flat on the floor. The back of the chair should support your lower back (lumbar region). Follow the manufacturer's instructions for adjusting the backrest to fit your body properly.

You might have to raise your chair so that your forearms and hands are at the proper angle to the keyboard. If this makes it impossible to rest your feet flat on the floor, you can use a footrest with adjustable height and tilt to make up for any gap between the floor and your feet. Or you can lower the desktop to eliminate the need for a footrest. Another option is to use a desk with a keyboard tray that's lower than the regular work surface.

External Mouse

If you use an external mouse, position the mouse at the same height as your keyboard and within a comfortable reach.

Built-in Display

Adjust the angle of the display to minimize glare and reflections from overhead lights and windows. Do not force the display if you meet resistance. The display is not meant to open past 140 degrees.

You can adjust the brightness of the screen when you take the computer from one work location to another, or if the lighting in your work area changes.

Getting More Information

Go to www.apple.com/about/ergonomics

Learning About Apple and the Environment

Apple Computer recognizes its responsibility to minimize the environmental impacts of its operations and products. Go to www.apple.com/environment/summary.html for more information.

You can use your computer to browse the World Wide Web, send email to friends and family, and chat in real time over the Internet. Use this detailed guide to connect to the Internet.

When you first start up Mac OS X, Setup Assistant helps you enter your Internet configuration information.

If you didn't use Setup Assistant to configure your Internet connection, you can use it now. Open System Preferences and click Network. Click the "Assist me" button and then click Assistant to open Network Setup Assistant. If you don't want to use Network Setup Assistant, you can use the information in this appendix to set up your connection manually.

There are four kinds of Internet connections:

- **Dial-up connection:** Your computer is plugged in to a phone wall jack using a phone cable (with computers that include a modem).
- **High-speed DSL or cable modem connection:** Your computer is plugged in to a special modem you get from an ISP using an Ethernet cable.
- **AirPort Extreme wireless connection:** Your computer is connected wirelessly to the Internet using an AirPort Extreme or AirPort Express Base Station.
- **Local area network (LAN):** Your computer is plugged in to a LAN using an Ethernet cable. This type of connection is usually used in the workplace.

Before you connect to the Internet:

- 1 Set up an account with an Internet Service Provider (ISP).
Use the information in this appendix to set up your connection.
- 2 Gather the connection information you need from your ISP or network administrator. See the next section, "Gathering the Information You Need," to find out what information to get for each type of connection.

In some cases, if another computer in the same location is already connected to the Internet, you may be able to use its settings.

To find the settings on a Mac OS X computer:

- Open the Network pane of System Preferences.
- Choose your connection method from the Show pop-up menu.
- Copy the information for your configuration.

To find the settings on a Mac OS 9 computer:

- Open the TCP/IP control panel.
- Find the connection method in the “Connect via” pop-up menu.
- Find the configuration in the Configure pop-up menu.
- Copy the IP address, subnet mask, and router address from the corresponding fields.

To find the settings on a Windows PC:

The connection information on a Windows computer resides in two places.

- To find the IP address and subnet mask, open the “Network and Internet Connections” control panel.
- To find user account information, open the User Accounts control panel.

You can write the information directly on the next few pages, and then enter it in Setup Assistant.

- 3 If you are using a dial-up modem, plug the phone cord (included with most Macintosh computers) in to your computer’s modem port and in to a phone wall jack. If you are using a DSL or cable modem, follow the instructions that came with the modem to connect it to your computer.
- 4 Turn on your computer and enter information in Setup Assistant to configure your Internet connection.

Note: If you already started your computer and did not use Setup Assistant to configure your Internet connection, choose Apple (🍏) > System Preferences and click Network. Then click “Assist me.” Setup Assistant opens.

Gathering the Information You Need

You can write the information you get from your ISP, your network administrator, or your other computer on these pages, and then enter it in Network Setup Assistant.

To set up a telephone dial-up connection, gather the following information:

- Service provider name
- User or account name
- Password
- ISP phone number
- Alternate phone number
- Dialing prefix to obtain an outside line

To set up a DSL, cable modem, LAN, or AirPort Extreme wireless connection, choose one of the following connection methods (ask your system administrator or your ISP, if you don't know):

- Manually
- Using DHCP with a manual address
- Using DHCP
- Using BootP
- PPP

If you're unsure which method to choose, "Using DHCP" can be a good choice, because the network supplies most of the required information for you automatically.

If you selected "Manually" or "Using DHCP with a manual address," gather the following:

- IP address
- Subnet mask
- Router address

Note: If you selected "Using DHCP with a manual address," you don't need a subnet mask or router address.

If you selected "Using DHCP," gather the following optional information (ask your ISP if you need it):

- DHCP client ID
- DNS servers

If you selected “PPP” (for PPPoE connections), gather the following:

- Service provider
- Account name
- Password
- PPPoE service name

The information below is optional. Ask your ISP or system administrator if you need it.

- DNS servers
- Domain name
- Proxy server

Entering Your Information

After gathering your specific setup information from your ISP or network administrator, you can click the “Assist me” button in the Network preferences pane to open Network Setup Assistant, or you can enter the information manually.

To enter your information manually, follow the steps that correspond to your connection method.

- Dial-up modem with Point-to-Point Protocol (PPP) connection (see page 78)
- Cable modem, DSL, or LAN connection using these configurations:
 - Manual (see page 82)
 - DHCP (see page 83)
 - PPPoE (see page 84)
- AirPort Extreme wireless connection (see page 86)

Connecting With a Dial-Up Modem

A dial-up modem is a common way to connect to the Internet. Your modem uses a method called Point-to-Point Protocol (PPP) to connect to an ISP.

Make sure your modem is plugged in to a phone line and you have the information from your ISP available (see page 77).

To set up Network preferences to connect using the internal modem port:

- 1 Choose Apple (🍏) > System Preferences from the menu bar.
- 2 Click Network.

- 3 Choose Network Port Configurations from the Show pop-up menu and select the On checkbox next to Internal Modem.

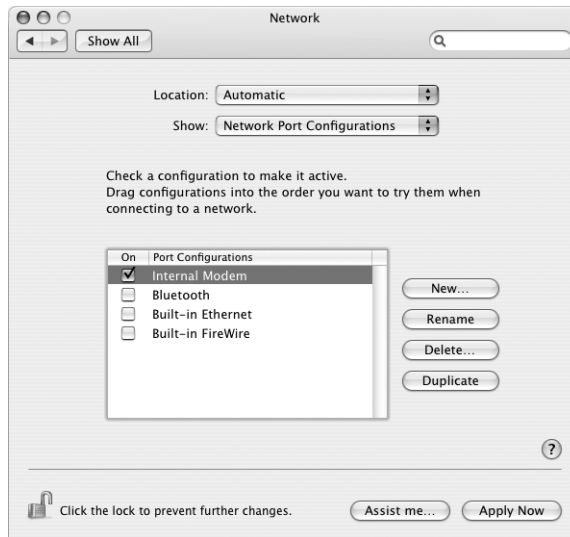

- 4 Drag Internal Modem to the top of the Port Configurations list to make it the preferred, or primary, network interface.
- 5 Choose Internal Modem from the Show pop-up menu and click PPP.
- 6 Enter the information from your ISP and click Apply Now.

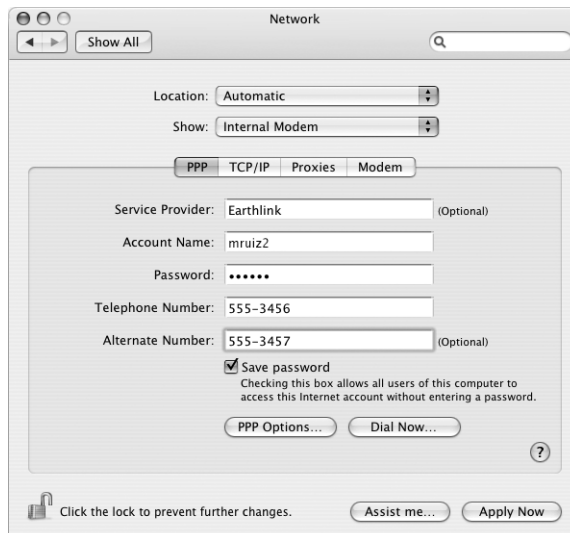

To test your Internet configuration:

- 1 Open the Internet Connect application (in the Applications folder).
- 2 Click the Internal Modem icon, if necessary.
- 3 Enter your dial-up phone number, account name, and password, if necessary.
- 4 Click Connect.

Internet Connect dials your ISP and establishes a connection.

To connect automatically when you start a TCP/IP application, such as a web browser or email:

- 1 Click PPP Options (in the PPP pane of Network preferences).
- 2 Select the “Connect automatically when needed” checkbox.

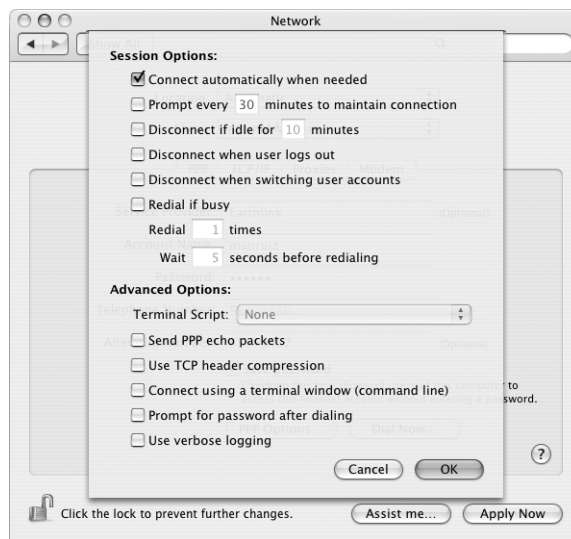

- 3 Click OK and Apply Now.

Connecting With DSL, Cable Modem, or LAN

If you connect to the Internet using a DSL or cable modem or Ethernet LAN, ask your ISP or network administrator how you should configure your Internet connection:

- **Manually:** With a manual configuration, your ISP or network administrator provides a static IP address and other information that you enter in Network preferences.
- **Using Dynamic Host Configuration Protocol (DHCP):** With a DHCP configuration, the DHCP server automatically enters the information for you.
- **Using Point-to-Point Protocol over Ethernet (PPPoE):** If you use a DSL modem and need a user name and password to connect to the Internet, you must configure your network to use PPPoE.

Make sure you have the information from your ISP available as you configure your network (see page 77).

To set up Network preferences for the built-in Ethernet port:

- 1 Choose Apple (🍏) > System Preferences from the menu bar.
- 2 Click Network.
- 3 Choose Network Port Configurations from the Show pop-up menu.
- 4 Select the On checkbox next to Built-in Ethernet.

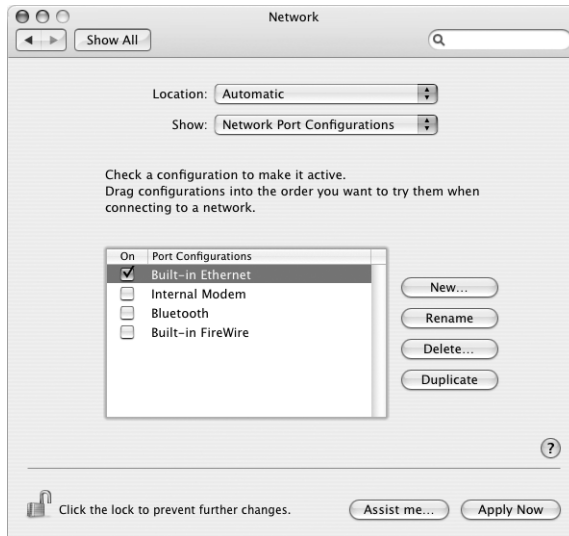

- 5 Drag Built-in Ethernet to the top of the Port Configurations list to make it the preferred, or primary, network interface.

Next, follow the instructions to configure your network manually, using DHCP or PPPoE, as instructed by your ISP or network administrator.

Configuring Manually

Have your static IP address, router address, and subnet mask from your ISP ready (see page 77).

To set up a manual configuration:

- 1 In Network preferences, choose Built-in Ethernet from the Show pop-up menu.
- 2 Click TCP/IP, if necessary.
- 3 Choose Manually from the Configure IPv4 pop-up menu.

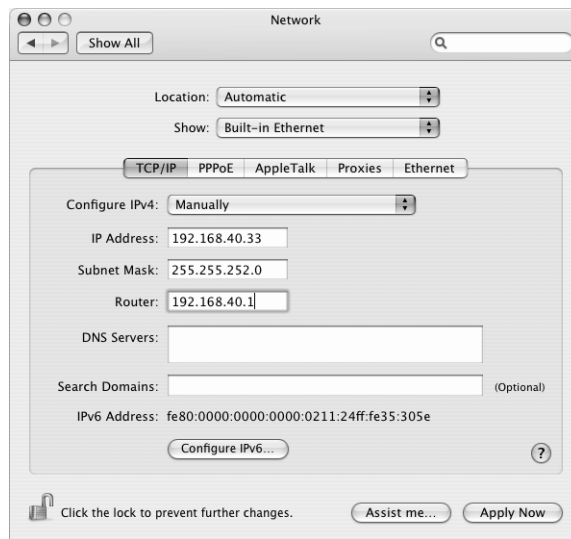

- 4 Type the information in the corresponding fields.
- 5 Click Apply Now.

After you configure your network, your connection is ready. Open your web browser (or another TCP/IP application) to test your Internet connection.

Configuring Using DHCP

After you set up a DHCP configuration, the DHCP server automatically provides your network information.

To set up a DHCP configuration:

- 1 In Network preferences, choose Built-in Ethernet from the Show pop-up menu.
- 2 Click TCP/IP, if necessary.
- 3 Choose Using DHCP from the Configure IPv4 pop-up menu.

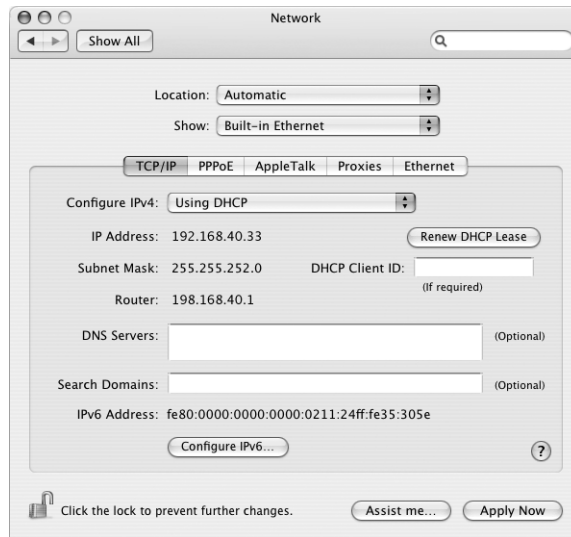

- 4 Click Apply Now.

Open your web browser (or another TCP/IP application) to test your Internet connection.

Note: Unless your ISP instructs you to do otherwise, ignore the DHCP Client ID field and the Search Domains field.

Configuring Using PPPoE

Some DSL-based ISPs use PPPoE. If you use a DSL modem and need a user name and password to connect to the Internet, check with your ISP to determine if you should connect using PPPoE.

To set up a PPPoE connection:

Have your user name, password, and if required, the domain name server (DNS) address from your ISP available (see page 77).

- 1 In Network preferences, choose Built-in Ethernet from the Show pop-up menu.
- 2 Click PPPoE and select “Connect using PPPoE.”

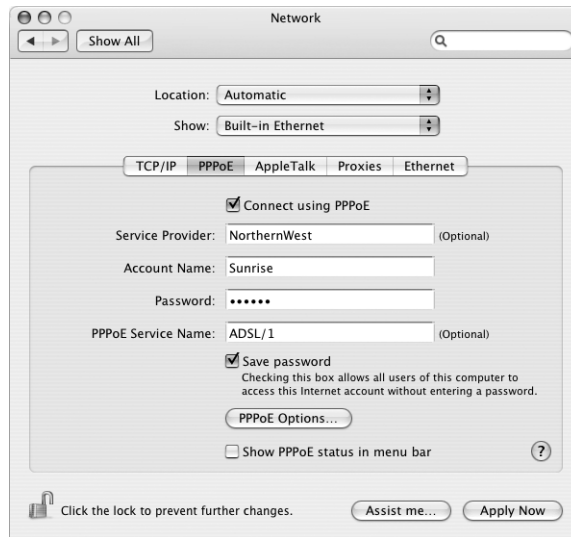

- 3 Type the information in the corresponding fields. If you want all users of your computer to use the same connection method, select “Save password.”

Note: To connect automatically when you start a TCP/IP application, such as a web browser or email, click PPPoE Options, and then select “Connect automatically when needed.”

- 4 Click TCP/IP and choose either Using PPP or Manually from the Configure IPv4 pop-up menu, as instructed by your ISP. If you have a static IP address from your ISP, choose Manually and type the address in the IP Address field.
- 5 Type the domain name server (DNS) addresses in the DNS Servers field.

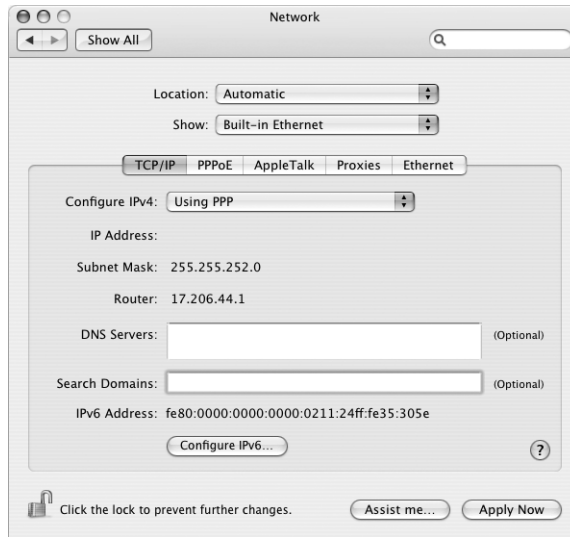

- 6 Click Apply Now.

After you configure your network, your Internet connection is ready. You can open your web browser or other TCP/IP application to test your connection.

Important: If you did not select the option to connect automatically, you need to open the Internet Connect application, choose the correct configuration, and then click Connect. For more information, choose Help > Internet Connect Help from the menu bar at the top of the display.

Configuring Your AirPort Wireless Connection

You can configure your AirPort Extreme network and Internet connection using AirPort Setup Assistant, located in the Utilities folder within your Applications folder. The assistant helps you configure the AirPort Express or AirPort Extreme Base Station and set up your computer to use AirPort Extreme. For more information about your base station, see the documentation that came with it.

If your AirPort Express or AirPort Extreme Base Station is already configured, in most cases your AirPort Extreme technology is ready to access it immediately.

To check if you have access to an AirPort network:

- Click the AirPort status icon in the menu bar and choose an AirPort network listed there.



If you don't see an AirPort network listed, you can use AirPort Setup Assistant to check or change your settings, or you can change them using the Network pane of System Preferences.

Setting Up an AirPort Connection Manually

Gather the following information from your system administrator if you'll be setting up a manual connection, which uses specific preassigned addresses for your servers and computer.

If you'll be connecting using DHCP, most of this information is provided to your computer automatically by the network, so ask your system administrator what is required.

- Domain name server (DNS) addresses, if necessary
- DHCP or manual IP address configuration
- IP address
- Router address
- Subnet mask
- Password, if required

Next, make sure your AirPort connection options are active in Network preferences.

To set up Network preferences for an AirPort connection:

- 1 Choose Apple () > System Preferences from the menu bar.
- 2 Click Network.
- 3 Choose Network Port Configurations from the Show pop-up menu.
- 4 Select the On checkbox next to AirPort.

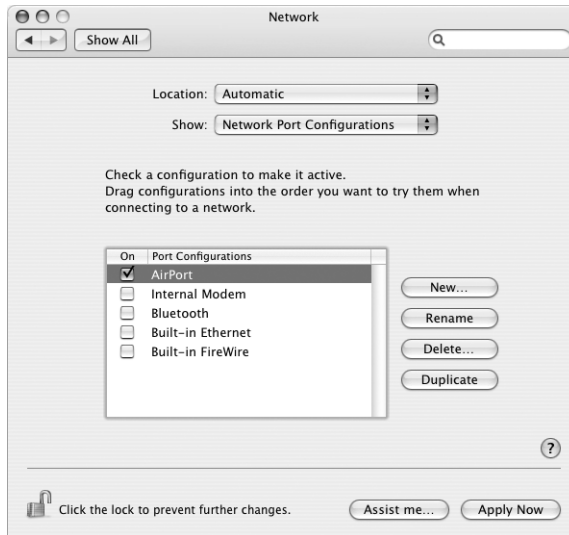

Next, follow the instructions to configure your network either manually or using DHCP, as instructed by your ISP or network administrator. If you're setting up your network yourself, it may be easier to configure the network using DHCP, because the server assigns IP addresses automatically.

- 5 Choose AirPort from the Show pop-up menu.
- 6 Click TCP/IP, if necessary.

- 7 In the Configure IPv4 pop-up menu, choose either Manually or Using DHCP.

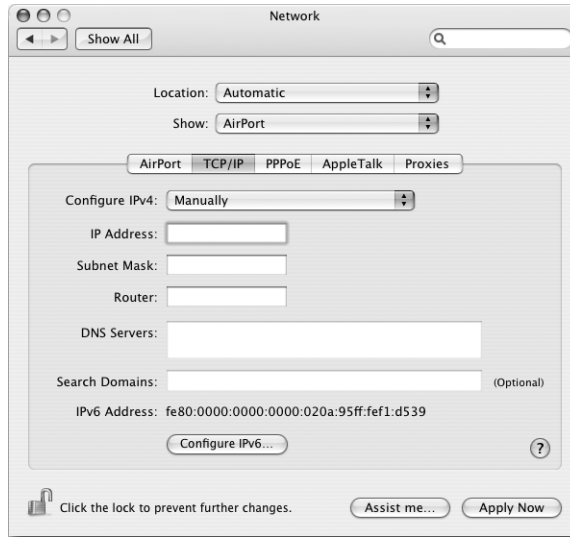

- If you chose *Manually*, type the other information in the corresponding fields.
 - If you chose *Using DHCP*, you don't need to enter any more information unless your system administrator has instructed you to do so.
- 8 Click AirPort and select options for joining an AirPort Extreme network after restarting or when your computer wakes from sleep.
 - 9 Click Apply Now.

After you configure your AirPort settings, you are ready to connect.

To test your AirPort Extreme connection:

- Click the AirPort status icon in the menu bar and choose Turn AirPort On. Any AirPort Extreme network in range should appear in the menu.

Troubleshooting Your Connection

Cable Modem, DSL, and LAN Internet Connections

If you can't connect to the Internet using your cable modem, DSL, or local area network (LAN), you can use Network Diagnostics to diagnose connection problems. Click "Assist me" in the Network pane of System Preferences, and then click Diagnostics to open Network Diagnostics. Follow the onscreen instructions.

If Network Diagnostics can't resolve the problem, there might be a problem with the ISP you are trying to connect to, with an external device you are using to connect to your ISP, or with the server you are trying to access. You can also try the suggestions in the following sections.

Important: Instructions that refer to modems do not apply to LAN users. LAN users may have hubs, switches, routers, or connection pods that cable and DSL modem users do not. LAN users should contact their network administrator rather than an ISP.

Check the cables and power supplies

Make sure all modem cables are firmly plugged in, including the modem power cord, the cable from the modem to the computer, and the cable from the modem to the wall jack. Check the cables and power supplies to Ethernet hubs and routers.

Turn the modem off and on and reset the modem hardware

Turn off your DSL or cable modem for a few minutes and then turn it back on. Some ISPs recommend that you unplug the modem's power cord. If your modem has a reset button, you can press it either before or after you turn the power off and on.

PPPoE Connections

If you are unable to connect to your ISP using PPPoE, first check the cables and power supplies, and then turn the modem off and on again to reset the modem hardware.

Check System Preferences settings

- 1 Choose Apple () > System Preferences from the menu bar.
- 2 Click Network.
- 3 Choose Network Port Configurations from the Show pop-up menu.
- 4 Drag Built-in Ethernet to the top of the Port Configurations list.
- 5 Choose Built-in Ethernet from the Show pop-up menu.
- 6 Click PPPoE.
- 7 Select "Connect using PPPoE."
- 8 Check the Account Name field to make sure you entered the correct information from your ISP.

- 9 If you chose to save your password, retype it to make sure it is correct.
- 10 Click TCP/IP. Make sure you've entered the correct information from your ISP in this pane.
- 11 Click Apply Now.

Network Connections

If you have two or more computers attempting to share an Internet connection, make sure that your network is set up properly. You need to know if your ISP provides only one IP address or if it provides multiple IP addresses, one for each computer.

If only one IP address is used, you must have a router capable of sharing the connection, also known as network address translation (NAT) or "IP masquerading." For setup information, check the documentation provided with your router or ask the person who set up your network. The AirPort Extreme Base Station can be used to share one IP address among multiple computers. For information about using the AirPort Extreme Base Station, check the onscreen help or visit the Apple AirPort website at www.apple.com/airport.

If you cannot resolve the issue using these steps, contact your ISP.

Do you have a question? Here are the top ten questions commonly asked by new iBook G4 users.

My Internet connection doesn't seem to be working. How do I set it up?

There are different types of Internet connections. For example, you can connect using a modem, a DSL connection, a wireless AirPort connection, or an Ethernet network. You will need to supply Mac OS X with specific information about your connection type, Internet service provider, or network. The first step in configuring your connection is gathering the information needed for your connection type. To find out what information you need and for instructions on how to configure your connection type, see Appendix C, "Connecting to the Internet," on page 75. Your computer also has a Network Setup Assistant to help walk you through setting up an Internet connection.

How do I set up my printer? Is it compatible with my iBook?

Begin by connecting your printer and installing any software according to the instructions that came with your printer. Next, open System Preferences and click the Print & Fax icon. Use the Print & Fax pane to configure your iBook to access the printer. You'll find lots of information about setting up printers in Mac Help (choose Help > Mac Help from the menu bar and search for "printer"). Also see "Connecting to a Printer" on page 28.

If your printer doesn't seem to be working as expected, you might need to check the manufacturer's website for updated print drivers. You can often download the latest printer software.

If you sent a print job to your printer, but it's not printing, check to see if the print job is stopped or on hold by clicking the printer icon in the Dock. (If no icon appears in the Dock, open Printer Setup Utility in the Applications/Utilities folder and double-click the printer's name.) If the window for the printer says "Job Stopped," click the Start Jobs button. If "Hold" appears beside the job name, resume printing by clicking the job name and then clicking Resume. If a print job has stopped printing because of a technical error, you can delete the faulty job by selecting the job and clicking Delete. You can then try printing the job again.

How does the Mac OS X interface work?

Users new to Mac OS X often have questions about how to carry out certain tasks. Your best source for Mac OS X information is Mac Help. You'll find introductory explanations for new users, users switching from Windows computers, and users upgrading from Mac OS 9. Open Mac Help by choosing Mac Help from the Help menu in the menu bar at the top of your screen. Browse the new Mac OS X user information listed there. Many of the basic tasks users are interested in involve the Finder, so try searching for "Finder," too.

How do I make my iBook battery last longer?

Remember to calibrate your battery when you first use it (see "Calibrating Your Battery" on page 17). You can conserve battery power by using the Energy Saver preference pane to specify how quickly the computer should go to sleep or dim the display. Open System Preferences and click the Energy Saver icon. Choose settings that are optimized for your type of usage. Using peripheral devices, such as hard disk drives, that get power from your computer can also shorten the amount of time your battery lasts. You can conserve battery power by disconnecting such devices. You can also purchase an additional battery that you can switch into your computer when power gets low. For more information about conserving battery power, see "Understanding Battery Conservation Tips" on page 50.

I put a disc in my optical drive, but nothing happened. How do I know if the disc is compatible with my optical drive?

Press the Media Eject key (⏏) to eject the disc. Apple slot-loading optical drives support only round 12 cm discs. Nonstandard discs and discs with noncircular shapes do not work in the optical drive. For more information about nonstandard discs, go to the Apple Service & Support website at www.apple.com/support and search for "nonstandard discs."

Warning: Inserting a nonstandard disc in to the optical drive can damage the drive.

How do I connect a monitor or TV to my iBook?

Your iBook comes with an external monitor port and an adapter for connecting devices with VGA connectors. You can also purchase an Apple Video Adapter and use it to connect many commonly used monitors, TVs, and video displays. If your device has a connector that is different from the adapter included with your iBook, you need to purchase a different adapter to connect it to the iBook. To see the adapter included with your iBook, look at the illustrations on page 5. For more information about connecting displays and other devices, see "Using External Video Support (VGA, Composite, and S-Video)" on page 41.

I forgot my password. How do I reset it?

You can reset your administrator password. See the instructions for resetting your password on page 63.

I hear a fan coming on and my iBook seems to get quite warm. Is that OK?

As your iBook operates, it's designed to keep itself within safe thermal limits. The fan comes on and stays on to keep the iBook operating at normal temperatures. The bottom of your iBook may become warm because it's designed to let heat dissipate through the case. This is normal. For more information, see "Using Your iBook G4" on page 71.

My application or Mac OS X doesn't seem to be working correctly. Do I need to reinstall Mac OS X?

The process of troubleshooting a problem requires that you answer several questions, such as whether a problem always happens with a specific application, is related to your operating system, or is a result of faulty hardware. Before you reinstall, see "Troubleshooting" on page 61 to help analyze the problem. Apple also provides many technical explanations and advice for solving problems on the Apple Service & Support website at www.apple.com/support. If you determine that you must reinstall Mac OS X, you'll find instructions in "Reinstalling the Software That Came With Your Computer" on page 65.

I installed an application on my iBook, but it doesn't seem to be working.**Where can I go for help?**

Check the documentation that came with the application for instructions on how to get support. Often manufacturers are aware of common problems that might occur with their applications and provide solutions and updates for immediate use. If your application is not an Apple product, you'll need to contact the manufacturer directly for the best support.

Communications Regulation Information

FCC Compliance Statement

This device complies with part 15 of the FCC rules. Operation is subject to the following two conditions: (1) This device may not cause harmful interference, and (2) this device must accept any interference received, including interference that may cause undesired operation. See instructions if interference to radio or television reception is suspected.

Radio and Television Interference

This computer equipment generates, uses, and can radiate radio-frequency energy. If it is not installed and used properly—that is, in strict accordance with Apple's instructions—it may cause interference with radio and television reception.

This equipment has been tested and found to comply with the limits for a Class B digital device in accordance with the specifications in Part 15 of FCC rules. These specifications are designed to provide reasonable protection against such interference in a residential installation. However, there is no guarantee that interference will not occur in a particular installation.

You can determine whether your computer system is causing interference by turning it off. If the interference stops, it was probably caused by the computer or one of the peripheral devices.

If your computer system does cause interference to radio or television reception, try to correct the interference by using one or more of the following measures:

- Turn the television or radio antenna until the interference stops.
- Move the computer to one side or the other of the television or radio.
- Move the computer farther away from the television or radio.
- Plug the computer in to an outlet that is on a different circuit from the television or radio. (That is, make certain the computer and the television or radio are on circuits controlled by different circuit breakers or fuses.)

If necessary, consult an Apple-authorized service provider or Apple. See the service and support information that came with your Apple product. Or, consult an experienced radio/television technician for additional suggestions.

Important: Changes or modifications to this product not authorized by Apple Computer, Inc., could void the EMC compliance and negate your authority to operate the product.

This product has demonstrated EMC compliance under conditions that included the use of compliant peripheral devices and shielded cables between system components. It is important that you use compliant peripheral devices and shielded cables between system components to reduce the possibility of causing interference to radios, television sets, and other electronic devices.

Responsible party (contact for FCC matters only): Apple Computer, Inc. Product Compliance, 1 Infinite Loop M/S 26-A, Cupertino, CA 95014-2084, 408-974-2000.

Bluetooth Information

FCC Bluetooth Wireless Compliance for Model A1041

The antenna used with this transmitter must not be collocated or operated in conjunction with any other antenna or transmitter subject to the conditions of the FCC Grant.

Bluetooth Industry Canada Statement

This Class B device meets all requirements of the Canadian interference-causing equipment regulations.

Cet appareil numérique de la Class B respecte toutes les exigences du Règlement sur le matériel brouilleur du Canada.

Bluetooth Europe–EU Declaration of Conformity

This wireless device complies with the specifications EN 300 328, EN 301-489, and EN 60950 following the provisions of the R&TTE Directive.

Industry Canada Statement

Complies with the Canadian ICES-003 Class B specifications. Cet appareil numérique de la classe B est conforme à la norme NMB-003 du Canada.

VCCI Class B Statement

情報処理装置等電波障害自主規制について

この装置は、情報処理装置等電波障害自主規制協議会 (VCCI) の基準に基づくクラス B 情報技術装置です。この装置は家庭環境で使用されることを目的としていますが、この装置がラジオやテレビジョン受信機に近接して使用されると、受信障害を引き起こすことがあります。

取扱説明書に従って正しい取扱をしてください。

Europe - EU Declaration of Conformity

Complies with European Directives

72/23/EEC, 89/336/EEC, 1999/5/EC

See <http://www.apple.com/euro/compliance/>

Laser Information

Warning: Making adjustments or performing procedures other than those specified in your equipment's manual may result in hazardous radiation exposure.

Do not attempt to disassemble the cabinet containing the laser. The laser beam used in this product is harmful to the eyes. The use of optical instruments, such as magnifying lenses, with this product increases the potential hazard to your eyes. For your safety, have this equipment serviced only by an Apple-authorized service provider.

If you have an internal Apple CD-ROM, DVD-ROM, or DVD-RAM drive in your computer, your computer is a Class 1 laser product. The Class 1 label, located in a user-accessible area, indicates that the drive meets minimum safety requirements. A service warning label is located in a service-accessible area. The labels on your product may differ slightly from the ones shown here.



Class 1 label



Service warning label

Exposure to Radio Frequency Energy

The radiated output power of AirPort Extreme is far below the FCC radio frequency exposure limits. Nevertheless, it is advised to use the wireless equipment in such a manner that the potential for human contact during normal operation is minimized.

Mouse and Keyboard Information

The Apple optical mouse is a Class 1 LED product. This product complies with the requirements of European Directives 72/23/EEC and 89/336/EEC.

It also complies with the Canadian ICES-003 Class B Specification.

High-Risk Activities Warning

This computer system is not intended for use in the operation of nuclear facilities, aircraft navigation or communications systems, or air traffic control machines, or for any other uses where the failure of the computer system could lead to death, personal injury, or severe environmental damage.

ENERGY STAR® Compliance

As an ENERGY STAR® partner, Apple has determined that standard configurations of this product meet the ENERGY STAR® guidelines for energy efficiency. The ENERGY STAR® program is a partnership with office product equipment manufacturers to promote

energy-efficiency. Reducing energy consumption of office products saves money and reduces pollution by eliminating wasted energy.

Disposal and Recycling Information

The backlight lamp in this product contains mercury. Dispose according to local, state, and federal laws.

For information about Apple's recycling program, go to www.apple.com/environment/summary.html

Battery Disposal

Dispose of batteries according to your local environmental laws and guidelines.

Deutschland: Das Gerät enthält Batterien. Diese gehören nicht in den Hausmüll. Sie können verbrauchte Batterien beim Handel oder bei den Kommunen unentgeltlich abgeben. Um Kurzschlüsse zu vermeiden, kleben Sie die Pole der Batterien vorsorglich mit einem Klebestreifen ab.

Nederlands: Gebruikte batterijen kunnen worden ingeleverd bij de chemokar of in een speciale batterijcontainer voor klein chemisch afval (kca) worden gedeponeerd.



Taiwan:



廢電池請回收

Telephone and Apple 56K Modem Information

Notify Your Telephone Company

Some telephone companies require that you notify the local business office when you hook up a modem to their lines.

Information You Need in the United States

The internal modem complies with Part 68 of the FCC rules. On the back of this equipment is a label that contains, among other information, the FCC registration number and ringer equivalence number (REN). If requested, provide this information to your telephone company.

- **Ringer equivalence number (REN):** 0.1B The REN is useful to determine the quantity of devices you may connect to your telephone lines and still have all those devices ring when your telephone number is called. In most, but not all areas, the sum of the RENs of all devices connected to one line should not exceed five (5.0). To be certain of the number of devices you may connect to your line, as determined by the REN, you should contact your local telephone company to determine the maximum REN for your calling area.

- *Telephone jack type:* USOC, RJ-11 An FCC-compliant telephone cord and modular plug are provided with this equipment. This equipment is designed to be connected to the telephone network or premises wiring using a compatible modular jack that complies with Part 68 rules. See the installation instructions for details.

Telephone Line Problems

If your telephone doesn't work, there may be a problem with your telephone line. Disconnect the modem to see if the problem goes away. If it doesn't, report the problem either to your local telephone company or to your company's telecommunications people.

If disconnecting the modem eliminates the problem, the modem itself may need service. See the service and support information that came with your Apple product for instructions on how to contact Apple or an Apple-authorized service provider for assistance.

If you do not disconnect your modem when it is adversely affecting the telephone line, the telephone company has the right to disconnect your service temporarily until you correct the problem. The telephone company will notify you as soon as possible. Also, you will be informed of your right to file a complaint with the FCC.

The telephone company may make changes in its facilities, equipment, operations, or procedures that could affect the operation of your equipment. If this happens, the telephone company will provide advance notice in order for you to make the necessary modifications to maintain uninterrupted service.

The internal modem will not work with party lines, cannot be connected to a coin-operated telephone, and may not work with a private branch exchange (PBX).

Telephone Consumer Protection Act

The Telephone Consumer Protection Act of 1991 makes it unlawful for any person to use a computer or other electronic device to send any message via a telephone fax machine unless such message clearly contains, in a margin at the top or bottom of each transmitted page or on the first page of the transmission, the date and time it was sent and an identification of the business or other entity, or individual sending the message and the telephone number of the sending machine of such business, entity, or individual.

Information You Need in Canada

The Industry Canada (IC) label identifies certified equipment. This certification means that the equipment meets certain telecommunications network protective, operational, and safety requirements. The Department does not guarantee the equipment will operate to a user's satisfaction.

Before installing this equipment, make sure that you are permitted to connect to the facilities of the local telecommunications company. Be sure you use an acceptable method of connection to install the equipment. In some cases, you may extend the company's internal wiring for single-line individual service by means of a certified telephone extension cord. Be aware, however, that compliance with these conditions may not prevent degradation of service in some situations.

Repairs to certified equipment should be made by an authorized Canadian maintenance facility designated by the supplier. Any equipment malfunctions or repairs or alterations that you make to this equipment may cause the telecommunications company to request that you disconnect the equipment.

In Canada, contact Apple at: 7495 Birchmount Road, Markham, Ontario, L3R 5G2, 800-263-3394

Warning: Users should ensure for their own protection that the electrical ground connections of the power utility, telephone lines, and internal metallic water pipe system, if present, are connected together. This precaution may be particularly important in rural areas.

Users should not attempt to make such connections themselves, but should contact the appropriate electric inspection authority or electrician.

- *Load number:* 0.1 The load number (LN) assigned to each terminal device denotes the percentage of the total load to be connected to the telephone loop that is used by the device, to prevent overloading. The termination of a loop may consist of any combination of devices, subject only to the requirement that the sum of the load numbers of all devices does not exceed 100.
- *Telephone jack type:* CA-11

Informations Destinées aux Utilisateurs Canadiens

L'étiquette d'Industrie Canada identifie un matériel homologué. Cette étiquette certifie que le matériel est conforme à certaines normes de protection, d'exploitation et de sécurité des réseaux de télécommunications. Le Ministère n'assure toutefois pas que le matériel fonctionnera à la satisfaction de l'utilisateur.

Avant d'installer ce matériel, l'utilisateur doit s'assurer qu'il est permis de le raccorder au réseau de l'entreprise locale de télécommunication. Le matériel doit également être installé en suivant une méthode acceptée de raccordement. Dans certains cas, le câblage appartenant à l'entreprise utilisé pour un service individuel à ligne unique peut être prolongé au moyen d'un dispositif homologué de raccordement (cordon prolongateur téléphonique).

L'abonné ne doit pas oublier qu'il est possible que la conformité aux conditions énoncées ci-dessus n'empêche pas la dégradation du service dans certaines situations. De fait, les entreprises de télécommunication ne permettent pas que l'on raccorde un matériel aux prises d'abonnés, sauf dans les cas précis prévus par les tarifs particuliers de ces entreprises.

Les réparations de matériel homologué doivent être effectuées par un centre d'entretien canadien autorisé désigné par la fournisseur. La compagnie de télécommunications peut demander à l'utilisateur de débrancher un appareil suite à des réparations ou à des modifications effectuées par l'utilisateur ou en raison d'un mauvais fonctionnement.

Veuillez contacter Apple pour des informations supplémentaires:

Apple Canada, Inc.
7495 Birchmount Road
Markham, Ontario
Canada L3R 5G2

Service à la clientèle d'Apple Canada: 800-263-3394

Avertissement : Pour sa propre protection, l'utilisateur doit s'assurer que tout les fils de mise à la terre du secteur, des lignes téléphoniques et les canalisations d'eau métalliques, s'il y en a, soient raccordés ensemble. Cette précaution est particulièrement importante dans les régions rurales.

L'utilisateur ne doit pas tenter de faire ces raccordements lui-même; il doit avoir recours à un service d'inspection des installations électriques ou à un électricien, selon le cas.

- *Numéro de charge:* 0.1 L'indice de charge (IC) assigné à chaque dispositif terminal indique, pour éviter toute surcharge, le pourcentage de la charge totale qui sera raccordée à un circuit téléphonique bouclé utilisé par ce dispositif. La terminaison du circuit bouclé peut être constituée de n'importe quelle combinaison de dispositifs pourvu que la somme des indices de charge de l'ensemble des dispositifs ne dépasse pas 100.
- *Type de prise téléphonique:* CA-11

Information You Need in the United Kingdom

This terminal equipment is intended for direct connection to the analogue Public Switched Telecommunications Network and is approved for use within the United Kingdom with the following features:

- Modem facility
- Autocalling facility
- Autoanswer facility
- DTMF signaling

Operation in the absence of proceed indication or upon detection of proceed indication

This product is in conformity with relevant regulatory standards following the provisions of European Council Directives 73/23/EEC (Low Voltage Directive) and 89/336/EEC amended by 92/31/EEC (EMC Directive).

Informationen für Deutschland

Diese Modem-Karte ist als Endeinrichtung vorgesehen und muss an ein TAE mit F-Kodierung angeschlossen werden. Diese Endeinrichtung ist in Konformität gemäss Niederspannungsrichtlinie 73 / 23 / EWG sowie EMC-Richtlinien 89 / 336 / EWG und 92 / 31 / EWG.

Informations pour la France

Ce matériel est conforme aux normes applicables de sécurité électrique d'après la directive 73 / 23 / CEE et aux normes applicables de comptabilité électromagnétique d'après la directive 89 / 336 / CEE, modifié par la directive 92 / 31 / CEE.

Information You Need in Australia

All telecommunications devices are required to be labelled as complying to the Australian telecommunications standards, ensuring the health and safety of the operator and the integrity of the Australian telecommunications network. To provide compliance with the Australian Communications Authority's technical standards, please ensure that the following AT commands are maintained:

- ATB0 (ITU/CCITT operation)
- AT&G0 (no guard tone)
- AT&P1 (33/66 pulse dial make/break ratio)
- ATS0 = 0 or ATS0 = 1 (no answer or answer greater than one ring)
- ATS6 = 95 (DTMF period between 70–255 ms)
- ATS11 = 95 (DTMF period between 70–255 ms)

For calls that are automatically generated, a total of three call attempts are allowed to a telephone number, with a minimum period between calls of 2 seconds. If the call does not connect after three attempts, 30 minutes must expire before automatic redialing may be initiated. Failure to set the modem (and any associated communications software) to the above settings may result in the modem being non-compliant with Australian telecommunications standards. Under these circumstances a user could be subject to significant penalties under the Telecommunications Act 1997.

This modem must be properly secured in order for you to use it. Telecommunications network voltages exist inside the computer and the telecommunications line connection must be removed before opening the computer.

Information You Need in New Zealand

This modem is fully approved to operate on the New Zealand telecommunications network under Telepermit number PTC 211/04/002. All telecommunications devices are required to hold a Telepermit and be labelled accordingly with the approved Telepermit number to comply with the New Zealand telecommunications standards, ensuring the health and safety of the operator and the integrity of the New Zealand telecommunications network. To ensure compliance, all calls that are automatically generated should not make more than 10 call attempts to the same number within any 30 minute period with a minimum period between calls of 30 seconds. Failure to adhere to these standards may result in the modem being non-compliant with New Zealand Telecom standards. Under these circumstances a user could be subject to significant penalties.

Important: The grant of a Telepermit for any item of terminal equipment indicates that only Telecom has accepted that the item complies with minimum conditions for connection to its network. It indicates no endorsement of the product by Telecom, nor does it provide any sort of warranty. Above all, it provides no assurance that any item will work correctly in all respects with another item of Telepermitted equipment of a different make or model, nor does it imply that any product is compatible with all of Telecom's network services.

A

- AC cord 6, 21
- AC plug 6, 21
- adapter
 - power 21
 - VGA 41
 - video 42
- adjusting your display 20
- AirPort Express 36, 37
- AirPort Extreme
 - about 36
 - antenna 13
 - Base Station 37
 - connection method 78
 - connections, setting up 77, 86
 - problems 63
- amber light 21
- analog phone line 7, 41
- antenna, AirPort Extreme 13
- Appearance preferences 25
- Apple 56K internal modem 41
- Apple Hardware Test 64
- Apple VGA Display Adapter 41
- Apple Video Adapter 42
- application freeze 26
- applications
 - installing 66
 - troubleshooting 63
 - using 26

B

- base station 37
- battery
 - calibrating 17
 - charging 49
 - conservation 50, 92
 - disposal 49
 - flashing lights 47
 - indicator lights 47
 - performance 47
 - power 50
 - replacing 48

- tips 50
- blinking question mark 11
- Bluetooth preferences 38, 39, 50
- Bluetooth technology 37
- brightness controls 13
- built-in speakers 13, 43
- burning DVDs 46
- buttons
 - display release 13
 - power 9, 13

C

- cable, RJ-11 41
- cable modem
 - connecting 7, 80
 - setting up 77
- calibrating your battery 17
- carrying your computer 69
- CD-R recording 45
- CD-RW recording 45
- CDs 43
- changing
 - the desktop 24
 - image size 20
 - password 63, 93
 - the resolution 20
 - the screen 20
 - System Preferences 24
- charging the battery 49
- checking memory 59
- Classic environment support 66
- cleaning your computer 69
- communicating using Bluetooth 37
- computer
 - disposal 96
 - freezes 62
 - inventory 5
 - putting to sleep 16
 - shutting down 17
 - turning on 9
 - won't turn on 62
- connecting
 - a modem 41

- Bluetooth devices 37
 - a cable modem 7, 80
 - a DSL modem 7
 - an Ethernet network 7
 - an external monitor 42, 92
 - external devices 32
 - FireWire devices 34
 - headphones 29
 - to Internet 9
 - a projector 42
 - a TV 42, 92
 - two computers 35
 - USB mouse 23
 - USB printers 32
 - a VCR 42
 - a video device 42
 - videocameras 34
 - wirelessly 36
- conserving battery power 50, 92
- controls
 - brightness 13
 - volume 13
- cord, AC 6, 21

D

- Dashboard 24
- Dashboard & Exposé preferences 25
- Desktop & Screen Saver preferences 25
- desktop, customizing 24
- DHCP
 - configuring 83
 - manual option 77
- dial-up connection 75, 77, 78
- dial-up modem 78
- discs
 - compatible 92
 - ejecting 44
 - inserting 43
 - software installation 65
- display
 - adjusting settings 20
 - cleaning 69
 - goes black 63
 - mirroring 42
 - release button 13
- Displays preferences 20, 42
- disposing of batteries 49
- disposing of your computer 96
- Dock 25
- Dock preferences 25
- document transfer 30
- downloading software 27
- drives, optical
 - compatible discs 92
 - disc sizes supported 43

- slot loading 13
- two-sided 44
- using 43

- DSL
 - configuration 80
 - modem 77

- DVD
 - burning 46
 - playing discs 45
 - recording 46

Dynamic Host Configuration Protocol (DHCP). *See* DHCP

E

- ejecting a disc 44
- Energy Saver preferences 50, 92
- ergonomics 73
- Ethernet
 - connecting to 7
 - networking capability 40
 - port 15, 40
- Exposé 24
- external
 - devices 32
 - microphones 43
 - monitor 42
 - monitor port 15

F

- fan noise 93
- file transfer 30
- finding your serial number 66
- FireWire
 - cable 35
 - connecting devices 34
 - devices and battery power 35
 - port 15, 34
 - Target Disk Mode 35
- Force Quit 26
- frozen application 26
- function key 13

G

- general safety 71
- green light 21

H

- hand positions 73
- headphone port 15
- headphones, connecting 29
- Hi-Speed USB. *See* USB

I

- image size 20
- inserting a disc 43

- installation instructions 5
- installing
 - applications 66
 - Classic support 66
 - Mac OS 9 66
 - Mac OS X 66
 - memory 54, 55
- internal modem
 - connecting 7
 - port 15
 - using 41
- Internet
 - configuration 80
 - connecting to 9
 - connection problems 64, 91
 - using Setup Assistant to connect 86
- Internet service provider 75
- inventory of items 5
- IP address, static 82
- ISP 75

K

- Keyboard & Mouse preferences 22
- keypad, numeric 23
- keys
 - function 13
 - Media Eject 13
 - Num Lock 13

L

- LAN connection
 - configuration options 80
 - setting up 77
- light
 - amber 21
 - battery 47
 - green 21
 - sleep indicator 13
- locating your serial number 66

M

- Mac OS 9, installing 66
- Mac OS X
 - installing 66
 - interface 92
 - learning about 24
- manual Internet configuration 82
- manually using DHCP router option 77
- Media Eject key 13
- memory
 - checking 59
 - installing 54, 55
- microphone 13, 43
- modem
 - cable 7, 75

- connecting 7, 41
- dial-up 78
- DSL 7, 75
- internal 7
 - using 41
- monitor, connecting 42, 92
- mouse
 - connecting external 23
 - See also* trackpad
- multiple USB devices 33
- music, recording 45

N

- Network Connections 90
- networking
 - two computers 35
 - wireless 36
- Network preferences 50, 64, 75, 76
- Network Setup Assistant 75, 91
- non-digital phone line 7
- numeric keypad 23
- Num Lock key 13

O

- opening your computer 13
- operating system 24
- optical drive
 - compatible discs 92
 - disc sizes supported 43
 - slot loading 13
 - two-sided 44
 - using 43

P

- password, resetting 63, 93
- phone line, analog 7
- playing
 - a video 45
 - CDs 43
 - DVD-Video discs 45
- plug, AC 6, 21
- Point-to-Point Protocol (PPP) 78
- Point-to-Point Protocol over Ethernet. *See* PPPoE
- ports
 - Ethernet 15
 - external monitor 15
 - FireWire 15
 - headphone 15
 - internal modem 15
 - power adapter 13
 - USB 15
 - video out 15
- power, battery 50
- power adapter
 - port 13

- safety tips 70
- using 21
- power button 9, 13
- PPPoE
 - configuring 84
 - connections 78, 89
 - using 80
- preferences. *See* System Preferences
- presentation mode. *See* display mirroring
- Print & Fax preferences 28, 91
- printing setup 28
- problems
 - computer freezes 62
 - computer won't respond 61
 - computer won't turn on 11, 62
 - display goes black 63
 - Internet connection 64, 89
 - pointer won't move 61
 - PPPoE connections 89
 - trouble ejecting a disc 64
 - trouble using AirPort 63
 - with an application 63
- projector, connecting 42
- putting your computer to sleep 16

Q

- question mark, blinking 11

R

- RAM. *See* memory
- recording
 - CD-R 45
 - CD-RW 45
 - DVD 46
 - music 45
- reinstalling software 93
- removing and replacing the battery 48
- resetting your password 63, 93
- resolution, screen 20
- RJ-11 cable 41

S

- safety
 - general instructions 71
 - power adapter 70
 - using your computer 71
- screen resolution 20
- scrolling trackpad feature 13, 22
- SDRAM specifications 53
- security slot 15, 51
- serial number 66
- setting up
 - a printer 28, 91
 - Internet connection 77
 - to connect manually 78

- Setup Assistant 8
- shutting down 17
- size, image 20
- sleep 16
- sleep indicator light 13
- software
 - applications 26
 - installation discs 65
 - reinstalling 93
 - updating 27
- Software Update preferences 28, 63
- Sound preferences 43
- speakers 13, 43
- specifications for SDRAM 53
- Spotlight 24
- Startup Disk preferences 35, 62
- static IP address 82
- stopping
 - an application 26
 - the computer 17
- storing your computer 70
- Sudden Motion Sensor 47
- System Preferences
 - Appearance 25
 - Bluetooth 38, 39, 50
 - customizing the desktop 24
 - Dashboard & Exposé 25
 - Desktop & Screen Saver 25
 - Displays 20, 42
 - Dock 25
 - Energy Saver 50, 92
 - Keyboard & Mouse 22
 - Network 50, 64, 75, 76
 - Print & Fax 28, 91
 - Software Update 28, 63
 - Sound 43
 - Startup Disk 35, 62

T

- telephone dial-up connection 75, 77, 78
- testing your Internet configuration 80
- trackpad
 - location 13
 - scrolling 13, 22
 - tips 22
 - using 10
- transferring
 - files or documents 30
 - information 35
 - information from another Mac 8
- troubleshooting
 - AirPort 63
 - an application 63
 - computer freezes 62
 - computer won't respond 61

- computer won't turn on 62
- display goes black 63
- ejecting a disc 64
- Internet connection 64
- pointer won't move 61
- your connection 89
- TV, connecting 92
- typing position 73

U

- Universal Serial Bus. *See* USB
- updating software 27
- USB
 - connecting mouse 23
 - connecting printer 32
 - devices and battery power 33
 - hubs 33

- multiple devices 33
- ports 15, 32

V

- VCR, connecting 42
- VGA adapter 41
- VGA connection 42
- video, playing DVD-Video discs 45
- video adapter 42
- video device, connecting 42
- video mirroring 42
- video out port 15
- volume controls 13

W

- wireless connections 36